



Rhode Island Department of Transportation

Road-Stream Crossing Design Manual

August 2021

prepared by  vhb



Table of Contents

Section 1: Introduction to the Manual	1-1
1.1 Scope of the Manual.....	1-1
1.1.1 Goal and Purpose of this Manual	1-3
1.1.2 What is a Stream Crossing?	1-3
1.1.3 How to use this Manual	1-3
1.1.4 What this Manual is Not	1-3
1.1.5 Important Definitions	1-3
1.2 Development of the Manual	1-4
1.3 Cost Comparison Analysis.....	1-5
1.4 Funding Opportunities.....	1-5
Section 2: Background and Design Rationale	2-1
2.1 Background and Importance of Road-Stream Crossing Design.....	2-1
2.1.1 Rationale for Stream and Habitat Continuity.....	2-1
2.1.2 Poor Existing Stream Crossings	2-1
2.2 Designing for Each Project Site.....	2-3
2.2.1 Selecting a Location	2-3
2.2.2 Site Assessment.....	2-3
2.2.3 Geomorphic Conditions.....	2-3
2.2.4 Hydrologic Conditions.....	2-4
2.2.5 Natural Resources	2-4
2.2.6 Cultural and Historical Resources.....	2-5
2.2.7 Wetland Areas	2-5
2.2.8 Crossing History	2-6
2.2.9 Safety Concerns	2-6
2.2.10 Cost and Logistics	2-6

Table of Contents (continued)

2.3 Planning for Climate Change	2-6
2.3.1 Precipitation	2-7
2.3.2 Sea Level Rise	2-7
Section 3: Design Approach	3-1
3.1 Approach #1—Stream Simulation Design (Geomorphic Design) [Preferred Approach]	3-2
3.2 Approach #2—Aquatic Organism Passage Design	3-2
3.3 Approach #3—Modified Hydraulic Design	3-2
Section 4: Design Standards	4-1
4.1 Road-Stream Crossing Design Standards	4-1
4.1.1 Conceptual Design Guidance	4-4
4.2 Design Criteria	4-4
4.2.1 Design Approach	4-5
4.2.2 Structure Type	4-5
4.2.3 Channel Velocities	4-5
4.2.4 Climate Change	4-6
4.2.5 Crossing Profile	4-7
4.2.6 Embedment, Substrate, and Channel Stability	4-8
4.2.7 Hydraulic Modeling	4-10
4.2.8 Openness Ratio	4-10
4.2.9 Stream Crossing Span	4-11
4.2.10 Structural Stability	4-13
4.2.11 Tidal/Coastal Modeling	4-13
4.2.12 Reporting Requirements	4-14
4.3 Existing Crossing Upgrades: Replacements and Retrofits	4-14
4.3.1 Replacement	4-15
4.3.2 Retrofit	4-15
4.4 Intermittent Streams	4-16

Table of Contents (continued)

Section 5: Permitting Agencies	5-1
Section 6: Final Design and Next Steps	6-1
6.1 Construction Dewatering.....	6-1
6.2 Operation and Maintenance (O&M)	6-1
Section 7: References.....	7-1

Appendices

Appendix A: Road-Stream Crossing Standards Review Checklists and Hydraulic Design Data Table	A-1
A.1: Road-Stream Crossing Standards Review Checklist—Existing	A-2
A.2: Road-Stream Crossing Standards Review Checklist—Proposed	A-3
A.3: Hydraulic Design Data Table.....	A-4
Appendix B: Conceptual Design Figures	B-1
Appendix C: Road-Stream Crossing Report Template.....	C-1
Appendix D: Glossary of Terms	D-1
Appendix E: Synthesis of Existing Guidance Memorandum.....	E-1
Appendix F: Diadromous Fish Passage Guidelines.....	F-1

List of Tables

TABLE 1. Flood Event AEP and Return Period1-4

TABLE 2. Overview of Road-Stream Crossing Design Standards. 4-2

TABLE 3. Hydraulic Design Requirements..... 4-3

TABLE 4. Permitting Agencies 5-1

TABLE 5. Time-of-Year Restrictions 5-1



Section 1: Introduction to the Manual

Rhode Island’s approximately 3,578 miles of riverine ecosystems, which flow to Narragansett Bay and the Atlantic Ocean, provide unique and diverse habitats that support a variety of species (Narragansett Bay Estuary Program, 2017). Rivers and streams are particularly vulnerable to fragmentation—being broken into small or separate parts—due to the linear nature of riverine ecosystems. The Rhode Island Department of Transportation (RIDOT) has developed this Road-Stream Crossing Design Manual (the Manual) to provide designers and engineers with design criteria and associated standards to prevent habitat fragmentation of riverine ecosystems, improve stream crossing function, and provide long-term resilient infrastructure. This Manual is designed to be used in conjunction with the *RIDOT Road-Stream Crossing Assessment Handbook* (2019) (the Assessment Handbook). This Manual assumes, but does not require, that existing crossings have been reviewed using the Assessment Handbook.

1.1 Scope of the Manual

This Manual is a guidance document focused on the design of safer, cost-effective stream crossings to meet transportation needs, improve hydraulic function, reduce maintenance costs, and enhance natural stream functions and wildlife migration. The design standards presented in this Manual (the Design Standards) apply to all RIDOT owned road-stream crossings. Other Rhode Island state agencies,

municipalities, regulators, and stream crossing designers are strongly encouraged to implement these standards.

Prior to publication of this Manual, RIDOT did not have agency-specific guidance governing stream crossing hydraulic design storm requirements and required freeboard. This Manual presents stream crossing design guidance based on capacity relative to current-day peak discharge, ecological connectivity, and resiliency for the future. Proposed crossing designs must also consider drainage area, highway functional classification, freeboard, flow velocities, backwater, and scour.

There are two levels of Design Standards presented in this Manual, the **Optimal Standards**, which must be achieved for all new and existing stream crossings, and the **Base Standards**. The Optimal Standards aim to match the natural floodplain geometry, as shown in *Figure 1-1* below. The Base Standards also allow for natural stream processes and aquatic passage but are less likely to accommodate movement of semi-aquatic and terrestrial wildlife or extreme flood events.

Figure 1-1: Diagram depicting the natural floodplain geometry of a stream corridor

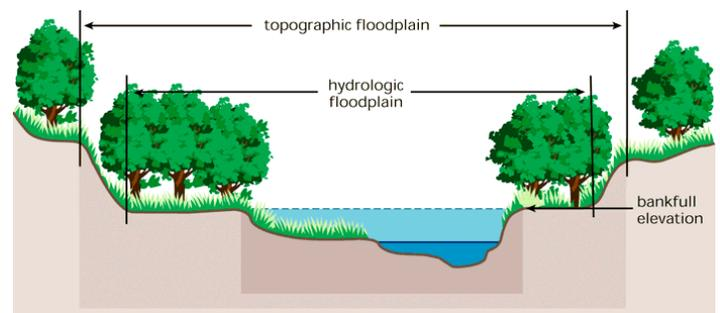

© (EPA, 2021)

Section 1: Introduction to the Manual

The Design Standards (Base and Optimal) apply to each of the Design Criteria categories. The Design Criteria are the topics that are impactful on the detailed design of a crossing structure and the project's decision-making process. **Each Design Criteria must be assessed individually for degree of compliance with the Design Standards.**

Road-stream crossing projects must adhere to these Design Standards for each Design Criteria as shown in *Figure 1-2* below and as follows:

- All **new road-stream crossings** are required to meet the Optimal Standards. If a new project is unable to meet Optimal Standards for all Design Criteria, the project must request written approval

(via email) from the RIDOT Environmental Division to design to the Base Standards.

- All **replacement road-stream crossings** (or retrofits) are required to meet the Optimal Standards. If a replacement project is unable to meet Optimal Standards for all design criteria, the project must request written approval from the RIDOT Environmental Division (via email) to design to the Base Standards or the Base Standards to the maximum extent practicable (MEP).

The RIDOT Environmental Division will review and approve project requests for non-compliance with the Optimal or Base Standards and will consider the overall benefits of meeting the Design Standards

Figure 1-2: Design Standard Requirements

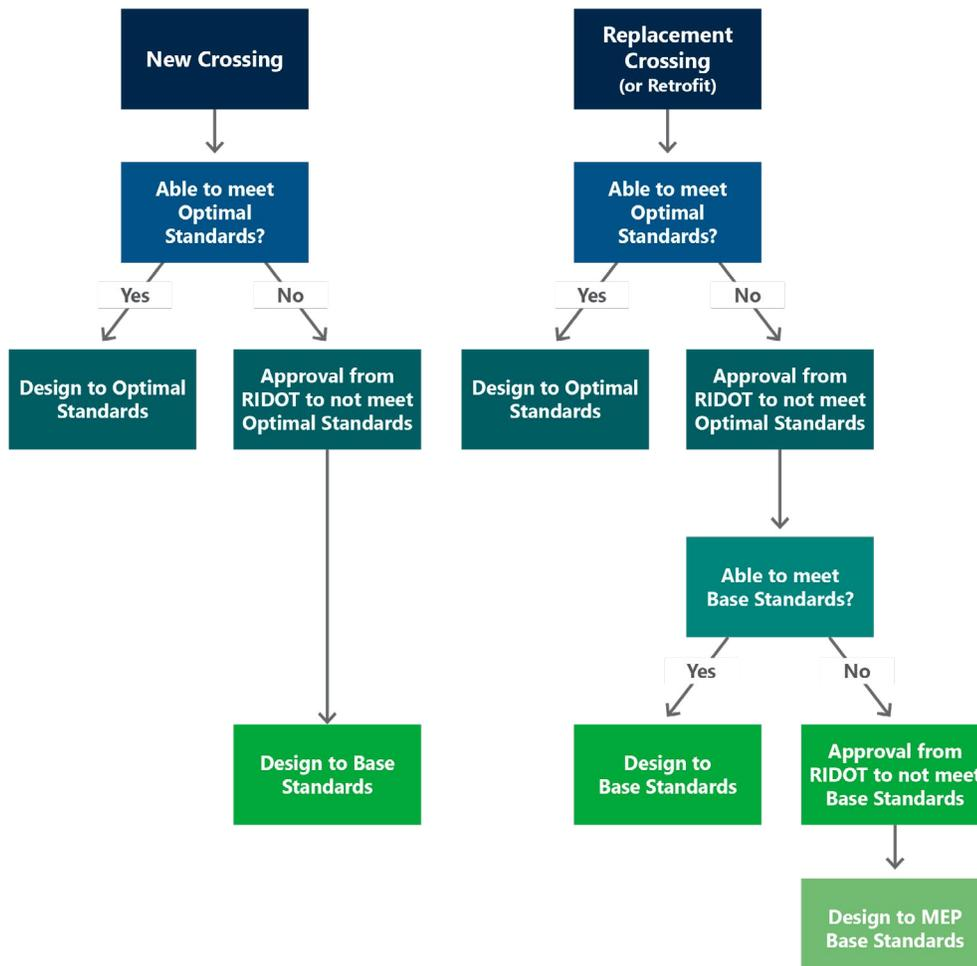

Section 1: Introduction to the Manual

compared to the constraints presented for non-compliance. **A crossing may meet the Optimal Standard for some Design Criteria and only meet the Base Standard for other Design Criteria, with RIDOT approval.**

1.1.1 Goal and Purpose of this Manual

As stated above, prior to publication of this Manual there had been no RIDOT-specific guidance governing stream crossing design. As a result, many existing crossings are undersized or improperly designed which can cause clogging, flooding, scour concerns, structural instability, or a variety of other issues discussed further in this Manual. These issues require RIDOT to utilize funding for maintenance, repairs, and frequent replacement. The Design Standards provided within this Manual require designers to provide crossings that are less likely to need RIDOT funding over time by creating standards for long-term resilience. [Section 2.2.10](#) below discusses case studies illustrating the reduction in life cycle costs by designing for organism passage and many of the other requirements described in this Manual.

1.1.2 What is a Stream Crossing?

Stream crossings include bridges, culverts, arches, and other similar structures that allow water to pass under infrastructure that would otherwise block the natural flow of rivers and streams. Crossings can vary significantly in size and shape, depending on the location and structure type. See [Assessment Handbook: Section 1.2.3](#) for additional detail.

1.1.3 How to use this Manual

The primary intended use of this Manual is to provide designers and engineers with criteria and guidelines to create more cost-effective, climate-resilient stream crossings that also improve wildlife passage and stream connectivity. A knowledge of hydrology, hydraulics, aquatic organism passage (AOP), geotechnical and structural design, at a minimum, is required for the proper design of a crossing. This Manual focuses on the

design of road-stream crossings, but the Design Criteria can be applied to other stream crossing infrastructure (e.g., pedestrian paths, bike paths, railroads, and pipelines) and other waterbodies including wetlands and tidally influenced areas. After reviewing the Design Standards presented in the Manual (see [Section 4](#)), designers must complete the Road-Stream Crossing Standards Review Checklist and Hydraulic Performance Data Table, provided in [Appendix A](#), to document the proposed crossing's compliance with the applicable Design Standards.

1.1.4 What this Manual is Not

This Manual is not intended for the following uses:

- A design guide for stormwater and other drainage pipes
- A replacement for the RIDOT Bridge Inspection Manual, the RIDOT Linear Stormwater Manual, or the Rhode Island Stormwater Design and Installation Standards Manual
- A guide for structural or geotechnical design and analysis of bridges, arches, or culverts
- An assessment guide for prioritizing stream crossing replacement
- A stream crossing permitting guidebook
- A guide for floodplain management or analysis

1.1.5 Important Definitions

This section provides only the specific key definitions with which all readers should become familiar. Additional definitions and abbreviations used in this Manual are provided in [Appendix D: Glossary of Terms](#). Definitions for hydraulic analysis (design storm, scour, check scour, and climate check) are provided in [Section 4.1](#) below.

Section 1: Introduction to the Manual

Annual Exceedance Probability (AEP): The probability of an event occurring in any year. For example, the 1% AEP flood has a 1% chance of occurring or being exceeded in any given year. The probability of flood occurrence is also commonly defined by a specific return period. This Manual refers to flood events in terms of AEP. *Table 1* shows the relationship between AEP and return interval for common flood events.

Table 1: Flood Event AEP and Return Period

Annual Exceedance Probability (AEP) (%)	Return Period (years)
50	2
10	10
4	25
2	50
1	100
0.2	500

Bankfull Width: A measurement of the active stream channel top width at bankfull flow (the point at which water completely fills the stream channel and where additional water would overflow into the floodplain). See *Assessment Handbook: Section 3.5.2* for additional detail on determining bankfull width and flow.

Bridge¹: A crossing that has a deck supported by abutments. Abutments may be earthen or constructed of wood, stone, masonry, concrete, or other materials. A bridge may have multiple cells, divided by one or more piers. See *Assessment Handbook: Section 1.2.3* for additional details.

Culvert: A culvert is any crossing structure that is not a bridge and is usually buried under some amount of fill. Culverts can be fully enclosed (contain a bottom) or have an open bottom. For the purpose of this Manual, an arch is considered an

open-bottom culvert. See *Assessment Handbook: Section 1.2.3* for additional details.

Freeboard: Freeboard is the distance between the upstream water surface elevation and the low chord of the crossing structure. The location of the upstream water surface elevation will vary based upon the hydraulic model used in the design. Below is a description of this location for common hydraulic modeling software:

- **HEC-RAS (Hydrologic Engineering Center River Analysis System):** Two cross sections upstream of the crossing (also known as Bridge Cross Section 4) where the flow has not yet been impacted by contraction of the crossing.
- **HydroCAD Stormwater Modeling Software:** The location of the upstream water surface elevation will vary based on the method of modeling. The designer should use engineering judgement to best interpolate the elevation approximately one to two bridge widths upstream of the crossing or where flow has not yet been impacted by contraction of the crossing.
- **HY-8 Culvert Hydraulic Analysis Program:** Due to the limitations of this model, the designer should utilize engineering judgement to determine if the predicted water surface elevation at the upstream face of the crossing is appropriate to use for freeboard calculations.

1.2 Development of the Manual

This Manual was developed with review and input from various stakeholder groups consisting of representatives from other state agencies, regulatory groups, research organizations, watershed groups, and Rhode Island municipalities. The Design Standards presented in this Manual are based on industry-leading standards and the most recently available research for road-stream crossing design. When developing the Design Criteria, emphasis was given to crossing standards required by other New England states. By providing two levels of standards, Base and Optimal

¹ The RIDOT Bridge Inspection Manual defines a bridge as a structure over a depression or an obstruction with a length of more than 20 feet (2013, as amended). Designers should review the latest RIDOT Bridge Inspection Manual for updated definitions.

Section 1: Introduction to the Manual

Standards, designers can balance ecological and biological objectives with the cost and logistics of implementing a design.

The stakeholder groups that assisted RIDOT in the development of this Manual include:

- Environmental Protection Agency (EPA)
- Narragansett Bay Estuary Program
- National Marine Fisheries Service (NMFS)
- National Park Service (NPS)
- RI Coastal Resources Management Council (CRMC)
- RI Department of Environmental Management (RIDEM)
- RI Department of Administration
- RI Emergency Management Agency (RIEMA)
- Save the Bay: Narragansett Bay
- University of Rhode Island
- U.S. Army Corps of Engineers (USACE)
- U.S. Fish and Wildlife Service (USFWS)
- Woonasquatucket River Watershed Council
- Various engineering firms and Rhode Island municipalities

1.3 Cost Comparison Analysis

A cost comparison analysis was conducted as part of the development of this Manual to provide guidance and context for upgrading existing crossings to allow for AOP. A common issue associated with stream crossing replacement is that many crossings damaged during large storm events are traditionally funded to be replaced in-kind, requiring the same structure design and size as prior to the storm event. This results in many undersized crossings being repeatedly damaged and replaced with a similarly poor functioning stream crossing. However, the Robert T. Stafford Disaster Relief and Emergency Assistance Act (the Stafford Act) signed into law November 23, 1988 and amended most recently in May 2019, does allow state DOTs and municipalities to apply for funding beyond replacing structures in-kind.

Prior to publishing this Manual, RIDOT reviewed the existing research available regarding cost-benefit analyses for a stream crossing, which ideally includes life cycle costs associated with design and construction, the benefits of a longer lifespan, and reduced maintenance costs. Available research-based case studies demonstrate that designing for AOP and stream continuity not only provides ecological and hydraulic benefits, but often reduces the overall life cycle cost because the crossing requires less maintenance and is less likely to fail and require subsequent replacement (Levine, 2013; Massachusetts Department of Fish and Game Division of Ecological Restoration, 2015; The Louis Berger Group Inc, 2017). It is also likely that the impacts of climate change, particularly the higher frequency of intense storms, will increase the costs of replacing undersized stream crossings in-kind by requiring more maintenance and earlier replacement (Levine, 2013). Further discussion and elaboration on this review is provided in [Appendix E: Synthesis of Existing Guidance Memorandum](#).

This Manual aims to reduce the overall life cycle cost of road-stream crossings by providing more resilient, longer lasting crossings. The designer and the RIDOT Environmental Division should consider life cycle costs of a proposed crossing before presenting or accepting non-compliant crossings.

1.4 Funding Opportunities

Financial and technical support may be available to assist with upgrading, replacing, or installing new crossings. Below is a list of some funding sources that may be available for projects in Rhode Island:

- EPA Southeast New England Program (SNEP) Watershed Grants
- EPA Wetland Program Development Grants
- FEMA Building Resilient Infrastructure and Communities (BRIC) (former Pre-Disaster Mitigation Program)
- FEMA Flood Mitigation Assistant (FMA)
- FEMA Hazard Mitigation Grant Program (HMGP)

Section 1: Introduction to the Manual

- Narragansett Bay Estuary Program (Narragansett Bay and Watershed Restoration Fund)
- National Fish and Wildlife Foundation
- National Fish Habitat Partnership
- National Oceanic and Atmospheric Administration's Restoration Center
- RIDEM Climate Resilience Fund
- RIDEM Riparian Buffer Restoration Grants
- U.S. Fish and Wildlife Service's National Fish Passage Program
- Wildlife Conservation Society Climate Adaption Fund

Section 2: Background and Design Rationale

This section of the Manual provides an overview of the importance of maintaining stream continuity, potential issues of poorly designed crossings, and site-specific constraints that may influence crossing design. Other crossing design considerations include accounting for changes in precipitation and sea level rise due to climate change and evaluating the life cycle cost of different crossing designs.

2.1 Background and Importance of Road-Stream Crossing Design

There are currently an estimated 4,300+ road and railroad crossings affecting Rhode Island streams² (RI Resource Conservation & Development Area Council, 2013). Many crossings do not allow for the natural movement of water, sediment, and migratory species due to poor hydraulic and ecological design. Research in the Northeast United States found that stream sections located above impassable culverts had fewer than half the number of fish species and total fish counts compared to streams above and below passable culverts (Letcher et al., 2011). By understanding the importance of stream continuity and common consequences of poorly designed crossings, designers can avoid isolating habitats and create safer, more cost-effective stream crossings.

2.1.1 Rationale for Stream and Habitat Continuity

The concept of stream continuity focuses on passage of all species, including fish, insects, amphibians, reptiles, and mammals, at areas of potential habitat

fragmentation. Stream continuity allows for various species to access vital habitats like feeding, breeding, and spawning locations. Many terrestrial animals, such as reptiles or mammals, are more tolerant of stream discontinuity but may experience negative impacts from road crossings if forced to cross where they are vulnerable to traffic and other dangers. Poorly designed or installed stream crossings can also degrade nearby habitat and create inhospitable conditions for native plants and animals.

2.1.2 Poor Existing Stream Crossings

Recognizing problems at existing stream crossings and their consequences is a critical step in evaluating crossings and designing to avoid problems in the future. Poor crossing design can lead to further degradation of stream quality, increase flood risk, and isolate habitats and species. Many existing road-stream crossings do not allow fish and other wildlife to freely migrate and do not meet the Design Criteria presented in this Manual. The *Assessment Handbook* provides extensive detail on reviewing and assessing existing crossings and understanding which design elements are priorities for improvement. The most common problems and consequences of poorly designed stream crossings are summarized below.

Crossing Clogging

Stream crossings can become clogged by woody debris, leaves, ice, and other material. This may create or exacerbate flooding and scour issues and make a crossing impassable to wildlife. Crossings usually clog at inlets because the structure is undersized. Clogging may be avoided by using a structure large enough to span the natural channel and provide sufficient freeboard to pass debris through the crossing opening. Routine maintenance can also help prevent clogging but can be costly. Debris loads (quantity and size) will vary based on project location and should be accounted for in the design.

² Based on a 2013 GIS analysis conducted by the USDA Natural Resources Conservation Service (NRCS).

Section 2: Background and Design Rationale



Example of clogged crossing

Damage or Failure

Damaged or failed crossings can be the result of a variety of causes that destabilize a crossing structure, many of which are listed below. Damaged or failed crossings can prevent fish and wildlife from accessing food, breeding areas and other important habitats, cause damage to roadways, property damage, and in the worst-case scenario, loss of life. Replacement or repair of damaged crossings is costly and may be avoided by properly designing structures for hydraulic events and debris loads.

Disruption of Transportation Services

A common and expensive consequence of poor stream crossing design is damage to infrastructure that disrupts transportation services. Washed-out and flooded roadways, railroads, or other infrastructure can make a location inaccessible and isolate homes, businesses, and institutions. Disruption of transportation services also creates a significant safety issue if used as an evacuation route or by emergency vehicles.

High or Low Velocities

Both high and low flows can prevent organism passage and may alter the stream geomorphology by erosion or aggradation of bed material. Crossing structures should be designed to create water velocities similar to the natural stream under a variety of flow rates.

Perched Crossings

Perched crossings are above the level of the stream bottom, typically at the downstream end, creating a waterfall effect from the crossing outlet. A perched crossing can further erode the natural streambed and is a significant barrier to wildlife migrating upstream or downstream.



Example of perched crossings

Ponding and Flooding

Ponding and flooding are the unnatural backup of water upstream of a crossing. This usually occurs at undersized crossings and may occur year-round, during seasonal high water or floods, or when a structure becomes clogged. Flooding can lead to property damage, impassible roadways, road and bank erosion, and severe changes in habitat.

Scouring

Scouring is the erosion of the natural substrate of a streambed, usually caused by increasing velocities due to the contraction or obstruction of flow. High water velocities and related flow alterations may cause a scour hole at the downstream end of a crossing and can also erode streambanks upstream and downstream of a crossing. Scouring may undercut a crossing or its foundations and compromise the stability of a crossing structure.

Section 2: Background and Design Rationale

Shallow Crossings

Shallow crossings have water depths too low for organism passage. Fish and other aquatic organisms need sufficient water depths to move through a stream crossing. Shallow crossings are often improperly designed or installed. Crossings should be designed to maintain water depths that are similar to the natural stream.

Undersized Crossings

Undersized crossings restrict natural streamflow, particularly during high flows, and may cause problems including scour, erosion, high flow velocity, clogging, ponding, and in extreme cases washout (failure) or flows overtopping the roadway. Crossings can also fail due to increased peak discharge rates as a result of climate change, watershed development, and other land use changes since the time of construction.

Unnatural or No Bed Material

Materials like metal and concrete are not natural for species that travel along the streambed. These smoother surfaces also have a lower roughness coefficient which can increase velocities through the crossing. A continuous layer of substrate within a structure should match the natural substrate of the surrounding stream to maintain natural conditions (depth and flow velocity) and not disrupt stream continuity.

2.2 Designing for Each Project Site

Designers must account for the specific needs and constraints of each project location, stream geomorphic conditions, hydrologic conditions, surrounding ecology, safety and transportation needs, and cost and construction constraints. The design of each crossing must include, but is not limited to, the considerations in the following sections:

2.2.1 Selecting a Location

The location of a proposed road-stream crossing should minimize impact to geomorphic processes and habitat continuity. Designers should avoid placing crossings in sensitive areas such as rare species habitat or unstable reaches. A crossing hydraulic opening must span the natural channel and minimize disturbance by aligning the crossing perpendicular to a straight segment of the stream channel, whenever possible.

2.2.2 Site Assessment

Designers must evaluate the site of a proposed crossing prior to designing a crossing structure to incorporate site-specific information. The [Assessment Handbook](#) provides detailed guidance on data collection for accurate site assessments including collection of field data and desktop analyses.

RIDOT recommends that designers evaluate any existing crossings that need replacement or upgrade by using the methodology outlined in the [Assessment Handbook](#) prior to the redesign of the crossing. Risk and impact scores from the [Assessment Handbook](#) can indicate which Design Criteria are most critical for replacement or retrofit design, discussed in more detail in [Section 4](#).

2.2.3 Geomorphic Conditions

The topographic and bathymetric conditions at a proposed crossing location must be analyzed during the pre-design process. Many elements of the design of the crossing, including the crossing alignment relative to the channel, crossing span, crossing slope, and substrate within the crossing, will be determined by the geomorphic conditions at the site. The observed upstream and downstream conditions of a crossing can also indicate potential issues with bank stability, changes in channel gradient, and habitat continuity to be addressed during the design process. See the [Assessment Handbook: Section 8](#) for analyzing the geomorphic processes that may impact the proposed project.

Section 2: Background and Design Rationale

2.2.4 Hydrologic Conditions

The hydrology of the stream and contributing watershed at a crossing location are critical in the structural design and hydrologic and hydraulic (H&H) modeling of the crossing. Hydrologic analysis for determining the range of flows at a site can include the use of peak-flow data from nearby stream gages, rainfall-runoff analysis, and regional flood-flow regression equations (available from United States Geological Survey (USGS) Scientific Investigations Report 2014–5010 (Bent et. al., 2014). See the [Assessment Handbook: Section 5](#) for guidance on determining flows at a project site and [Section 6](#) for guidance on evaluating the hydraulic capacity of an existing crossing. Streamflow data (velocity, depth, and discharge rates) from the proposed design model results should be comparable to the natural stream. The locations of hydraulic features (e.g., reservoirs, dams, pump stations) must also be accounted for during modeling and design.

2.2.5 Natural Resources

Designers must review the potential for impacts to natural resources and may be required to perform studies to evaluate these impacts. Projects may require additional permitting and design considerations. Regulatory limitations to protect resources near the project may also limit construction timing to specific weeks or months during the year. Common natural resources that may impact the design and permitting of a project are discussed below.

Threatened and Endangered Species

If a crossing has the potential to occur in an area of state-listed or federally threatened or endangered species, the project may require review by the U.S. Fish and Wildlife Service (USFWS), the National Marine Fisheries Service (NMFS), RIDEM, or other regulating entities for compliance with the Endangered Species Act. The designer must assess if an aquatic species study is necessary to account for passage in the design when designing for passage of a specific organism.

Designers must review the most recent [list of threatened or endangered species](#) and their associated [critical habitats](#), available from the USFWS, the NMFS, and the Rhode Island Natural History Survey (rinhs.org) to understand the requirements for design.

Essential Fish Habitat

If the proposed project has the potential to impact essential fish habitat (EFH) or NOAA trust resources, the project may require review by the National Marine Fisheries Service (NMFS) for compliance with the Magnuson-Stevens Fishery Conservation and Management Act (MSA). The designer must assess if an aquatic species study is necessary to account for passage in the design when designing for passage of a specific organism. If a crossing is located within EFH, designers may have to consult the NMFS to determine the impacts. A [map of EFH](#) is available online from the NMFS.

Migratory Birds

If a proposed project has the potential to impact migratory birds, the project will require compliance with the Migratory Bird Treaty Act (MBTA). The MBTA is regulated by the USFWS to promote the conservation of migratory bird populations. A list of bird species protected under the MBTA can be found in 50 CFR § 10.13. Common construction restrictions may include minimizing land disturbance, limiting the use of artificial lighting, noise restrictions, and material containment.

Wild and Scenic Rivers

The National Wild and Scenic Rivers System was created to preserve certain rivers with outstanding natural, cultural, and recreational values. Approximately 110 miles of Rhode Island's 1,392 miles of river are designated as Wild and Scenic Rivers (USFWS, 2021). If a crossing is located at a National Wild and Scenic River, designers must consult the National Park Service for early coordination. A map of [Rhode Island Wild and Scenic Rivers](#) is available online.

Section 2: Background and Design Rationale

Invasive Species

If a proposed project has the potential to introduce or spread invasive species, methods must be implemented to prevent the introduction and spread of invasive species that comply with federal and state laws and regulations. The designers and planners shall consider and address, to the extent practicable, the impacts of invasive species in all aspects of project planning, design, construction and maintenance.

2.2.6 Cultural and Historical Resources

An existing crossing that needs replacement or upgrade may be listed or impact an entity on the National Park Service's National Register of Historic Places. Designers should consult the RIDOT Cultural Resources Unit, the *Rhode Island Historical Preservation & Heritage Commission*, the National Park Service and review the most recent information from the *National Register of Historic Places* to determine if the project will impact structures on the National Registry. The redesign of a structure on the National Register of Historic Places may be limited due to regulations required by the National Historic Preservation Act.

2.2.7 Wetland Areas

Crossings within wetlands should be designed to minimize disturbance to streambeds, wetland soils, other vegetation, and water surface elevations of the wetland. Designers should balance the goals of the project with any required clearing or filling of wetlands and should be designed to traverse a narrow section of the wetland, to the maximum extent practicable. Time-of-year (TOY) restrictions may be required by regulatory agencies to limit construction activities to low-flow periods to minimize impact to aquatic organisms (see [Section 5](#)).

The design of a crossing within a wetland or wetland buffer zone will need to comply with freshwater and/or coastal wetlands regulations as administered by the RIDEM and/or the RI CRMC. Designers must comply with the standards and avoidance, minimization, and mitigation measures established within the Rules and Regulations Governing the Administration and Enforcement of the Fresh Water Wetlands Act (250-RICR-150-15-1) as administered by the RIDEM, or the Coastal Resources Management Program (650-RICR-20-00-1), or Rules and Regulations Governing the Protection and Management of Freshwater Wetlands in the Vicinity of the Coast (650-RICR-20-00-2) as administered by the RI CRMC. The location of the project will determine the jurisdiction of the regulatory agency and the applicable regulations. The jurisdictional boundary between RIDEM and RI CRMC is hosted on the *RIDEM Environmental Resource Map*. If a project includes the jurisdiction of both agencies, then it is generally RI CRMC that will take sole jurisdiction, though this should always be verified on a project-by-project basis with the regulatory agencies.

Section 404 of the Clean Water Act (CWA) establishes a program to regulate the discharge of dredged or fill material into waters of the United States, including wetlands (U.S. EPA, 2019). Therefore, approval from the United States Army Corps of Engineers is required for any projects proposing fill or dredging within a wetland area, although certain activities may be exempt. Projects are regulated through a permit review process in conjunction with RIDEM and/or RI CRMC for approval under the RI General Permit.

Section 2: Background and Design Rationale

2.2.8 Crossing History

Crossing replacement projects must consider the hydraulic history of the existing crossing and the surrounding area. The designer must investigate if the crossing or surrounding area has a history of flood issues, overtopping, scouring, clogging, wash-out/collapse, or impacts to terrestrial or aquatic organism crossing. Evidence of wildlife passage issues may not always be obvious (for example, vernal pools near roadways but with no visible roadkill) and must be analyzed where topography and surrounding land use suggest that a crossing may be heavily trafficked by wildlife. Areas that serve as “critical linkages” for wildlife movement and connectivity in Rhode Island are available through the Critical Linkages data developed by the Landscape Ecology Lab at UMass Amherst as part of the Conservation Assessment and Prioritization System (CAPS) program (see [Assessment Handbook: Section 12.2 of the Assessment Handbook](#)). The designer should also inquire with the town, RIDOT, and community representatives to obtain any available records, reports, or photographs of the culvert history. If the crossing has a history of creating adverse conditions, RIDOT recommends that the crossing is not replaced-in-kind. The crossing should be analyzed and designed to improve conditions, reduce the risk of failure or damage, and meet the Standards described within this document.

2.2.9 Safety Concerns

The design of a crossing structure and factor of safety depend heavily on the roadway use, location, highway functional classification, and flood impact potential. During high flood events, a crossing must maintain safety for the intended use of the roadway and minimize impacts to surrounding areas and infrastructure. Flood frequency requirements based on highway functional classification and crossing span are summarized in [Table 3: Hydraulic Design Requirements](#). The “RIDOT Roads” layer available online from the

Rhode Island Geographic Information System (RIGIS) clearinghouse can be used to determine highway functional classifications, E-911 primary routes, and hurricane evacuation routes. See the [Assessment Handbook: Section 11](#) for further discussion on the importance of transportation safety concerns.

In addition to flood damage, some road-stream crossings may create safety concerns due to animal-vehicle collisions. Animal-vehicle collisions occur at higher rates in Rhode Island compared to the national average, with an average of 1 in 84 drivers colliding with an animal on the road (AASHTO Journal, 2018), likely due to higher densities of deer populations and roadways within the state (USDA, 2016; United States Department of Transportation, 2016). Animal-vehicle collision rates can be reduced by accommodating terrestrial animal passage within the crossing, discussed further in [Section 4](#).

2.2.10 Cost and Logistics

Project cost and logistics are often the most significant constraints when designing a road-stream crossing. Construction feasibility, right-of-way (ROW) limitations, and regulatory requirements may limit the crossing location or structure design. ROW limitations are common for projects within roadways and often limit the project extents to the immediate area within the roadway easement. These constraints must be balanced with the overall safety, construction cost, life cycle cost, and the ecological and hydraulic requirements of a crossing to develop a design within the project scope.

2.3 Planning for Climate Change

The climate change predictions from the Intergovernmental Panel on Climate Change (IPCC) have had multiple iterations of publications and have increased the severity of climate change with each new publication (Collins et al., 2013). For this reason, climate change must be accounted for as part of the proposed stream-crossing manual. As part of its 1,045 square

Section 2: Background and Design Rationale

mile land mass, the State of Rhode Island has 384 miles of coastline resulting in a significant number of tidally influenced stream crossings (NOAA, 1975). The climate change planning requirements for crossing design are summarized in [Table 3: Hydraulic Design Requirements](#) and expanded upon in [Section 4.2.4](#).

2.3.1 Precipitation

Average and extreme precipitation in the Northeast has increased during the last century. Intense rainfall events (heaviest 1% of all daily events from 1901 to 2012 in New England) have increased 71% since 1958 (Rhode Island Statewide Climate Resilience Action Strategy, 2018). More intense rainfall events lead to higher flood frequency and flood severity, which must be accounted for when designing a road-stream crossing. A crossing designed for the current 2% AEP storm event, for example, may not have the ability to accommodate the future 2% AEP storm event over the lifetime of the crossing. Therefore, precipitation projections must be considered in the design of all crossing. This Manual recommends analyzing climate change based on future planning horizons. A future planning horizon is the length of time into the future that is accounted for in a climate change projection. The future precipitation planning horizon that RIDOT requires for each project depends on the span and the highway functional classification at the crossing (as defined by RIDOT). The future planning horizon requirements are summarized in [Table 3: Hydraulic Design Requirements](#) and expanded upon in [Section 4.2.4](#).

2.3.2 Sea Level Rise

As part of its 1,045 square mile land mass, the State of Rhode Island has 384 miles of coastline resulting in a significant number of tidally influenced the stream crossings (NOAA, 1975). The mean sea level has risen over 10 inches in Rhode Island since 1930, and the rate of sea level rise in Newport during the period of 1986 to 2016 has exceeded the global average mean at 0.16 inches per year over the same period (Rhode Island Statewide Climate Resilience Action Strategy,

2018). Rhode Island is also expected to experience increases in the frequency and intensity of coastal storms, storm surge, and increased high tides. The impacts of sea level rise must be evaluated or modeled at all tidally influenced crossings and for those that will be exposed to the future Mean Higher High Water (MHHW) level based on the projected sea level rise of the planning horizon (as a project location may be tidally influenced under the future sea level rise scenarios). The future sea level rise planning horizon that RIDOT requires for each project depends on the span and highway functional classification at the crossing (as defined by RIDOT).

Section 3: Design Approaches

This section of the Manual discusses the recommended design approaches for designing a stream crossing and the benefits and drawbacks of each approach. The three design approaches presented are: (1) **Stream Simulation Design**, (2) **Aquatic Organism Passage Design**, and (3) **Modified Hydraulic Design**. The design approaches apply to all new, replacement, or retrofit crossings (as described in *Section 1.1*). Each approach has a unique methodology and area of focus for the basis of design.

The traditional design approach for road-stream crossings is to allow water to flow under roads, railroads, and other manmade infrastructure by conveying a specific design flow rate without washing-out or overtopping. However, with this traditional design approach, many of the existing crossings within Rhode Island are inadequately sized. A 2016 study of 421 stream crossings within the Wood-Pawcatuck Watershed found that 37% of the existing stream crossings were hydraulically undersized and unable to pass the 4% AEP peak discharge (Fuss & O'Neill). In addition to being undersized, many crossings were designed without considering AOP or stream continuity. This highlights the importance of incorporating appropriate hydraulic design and aquatic passage into stream

crossing designs moving forward. The design approaches presented below provide a unique methodology for developing a stream crossing design that will provide AOP and will convey the applicable peak discharges.

Sections 3.1-3.3 describe the **three main design approaches** that are currently acceptable to achieve hydraulic performance and provide a reasonable level of organism passage. Each design approach discusses the associated benefits and drawbacks which should be balanced with project goals and constraints.

3.1 Approach #1: Stream Simulation Design (Geomorphic Design) Preferred Approach

Stream Simulation, also known as geomorphic design, is the preferred design approach for road-stream crossings. Stream Simulation was developed by the United States Forest Service (USFS) and published in the 2008 document, *Stream Simulation: An Ecological Approach to Providing Passage for Aquatic Organisms at Road-Stream Crossings (FSSWG)*.³ Stream Simulation "is an approach to designing crossing structures (usually culverts), that creates a structure that is as similar as possible to the natural channel" (FSSWG, 2008). The premise of Stream Simulation design is to create a stream crossing that mimics the characteristics of the natural channel in as many facets as possible, so that the simulated channel presents no

³ The Stream Simulation technique was first formalized in the Washington Department of Fish and Wildlife's 1999 Fish Passage Design at Road Culverts and widely implemented in the Pacific Northwest from the Washington Department of Fish and Wildlife's 2003 Design of Road Culverts for Fish Passage (Bates).

Section 3: Design Approaches

more of an obstacle to aquatic animals than the natural channel and does not impede the natural movement of floodwater or sediment.

Designers utilizing this approach should reference the USFS Stream Simulation document for additional details on this approach. Stream Simulation has been widely accepted in New England and is often considered the top industry standard.

The design process should begin by identifying an undisturbed reference reach for the simulated channel to be based upon. The reference reach is preferably upstream, near the project location, and exists at a similar slope to the proposed crossing (FSSWG, 2008). If designing a crossing replacement, the reference reach should be outside of the influence of the existing crossing or other nearby infrastructure. The crossing structure is then designed over and around the proposed simulated channel. This method requires that the crossing's hydraulic opening span 1.2 times the bankfull width (BFW) with banks on both sides for dry passage for semi-aquatic and terrestrial wildlife and is embedded into the channel if using a closed-bottom structure. Whenever feasible, the banks within the crossing should be constructed out of natural streambank material and planted with native, shade-tolerant vegetation.

Regardless of the crossing structure, Stream Simulation structures have a continuous streambed that mimics the slope, dimensions, and material of the natural streambed to allow for unrestricted movement of aquatic species and some terrestrial species.

Benefits: Most likely to allow for unrestricted movement of terrestrial and aquatic organisms, account for hydraulic design requirements, and mimic natural channel characteristics.

Drawbacks: May result in a larger, more expensive crossing and requires additional survey of a reference reach.

3.2 Approach #2: Aquatic Organism Passage Design

Aquatic organism passage (AOP) design uses streambed sediment transport analysis to aid the design for AOP. This approach is outlined by the U.S. Department of Transportation Federal Highway Administration (FHWA) publication *Hydraulic Engineering Circular No. 26 (HEC-26)* and should be referenced by the designer if using this approach (2010). The size of stream crossing is primarily based on the minimum required hydraulic event, bed material composition, and permissible shear stress. Similar to the Stream Simulation approach, AOP design aims to mimic natural stream conditions under various flow rates to allow for movement of aquatic species but does not require a specified crossing span. Depending on the goals of the project, AOP design may also include using an aquatic species study to design for water depths and velocities that meet the swimming abilities of target fish populations and life stages during specific periods of fish movement. This method requires more complex analysis of friction and energy losses, bed material gradation, and use of one-dimensional energy and momentum equations, which may introduce error in the final design if inaccurate.

Benefits: Accounts for aquatic organism passage and hydraulic design requirements.

Drawbacks: Does not account for terrestrial organism passage, requires more detailed analyses, and may not be properly sized for extreme hydraulic events.

3.3 Approach #3: Modified Hydraulic Design

Modified hydraulic design is the analysis and design of a crossing structure based upon hydraulic and structural analyses which account for sufficient flow capacity (including freeboard requirements), bankfull width, channel slopes, and natural channel velocities. Similar to the AOP design approach, this method aims to mimic water depths and velocities of the natural channel to allow for movement of aquatic organisms,

Section 3: Design Approaches

but with an emphasis on meeting flow capacity requirements. Modified hydraulic design is based on traditional hydraulic design, which accounts for flow capacity and regulated required freeboard and does not consider AOP. Traditional hydraulic design has been found to have negative impacts to AOP and is more likely to wash out or otherwise fail, and therefore, is generally no longer accepted within the discipline.

Modified hydraulic design is often used in retrofit projects including flow control structures such as baffles, weirs, or oversized substrate utilized to create acceptable hydraulic conditions. This technique may result in a smaller diameter crossing but installation costs are highly variable due to unique designs of baffles, weirs, steps, or other controls. Modified hydraulic design may require more detailed hydraulic calculations and produces a less conservative design for fish passage than Stream Simulation or AOP design.

Benefits: May result in a smaller, less expensive crossing

Drawbacks: Does not account for all organism passage and requires more detailed hydraulic calculations

Section 4: Design Standards

This section of the Manual provides the Design Standards that apply to all RIDOT owned road-stream crossings. There are two levels of Design Standards presented in this Manual, the Base Standards and the Optimal Standards, each of which apply to each of the Design Criteria categories. All road-stream crossings (new, replacement, or retrofit), are required to meet the Optimal Standards for each Design Criteria. **If project specific needs or constraints do not allow the crossing (new, replacement, or retrofit) to meet the Optimal Standards for all Design Criteria, the crossing may reduce to meeting the Base Standards or the Base Standards to the MEP (for replacement/retrofit only) for some or all Design Criteria. For either condition, the designer is required to obtain written approval from the RIDOT Environmental Division.** See *Section 1* and *Figure 1-2* for description and application of the Standards.

The following items must be included as part of the 30% Design Submission to be reviewed and approved by the RIDOT Environmental Division:

- Road-Stream Crossing Standards Review Checklist (provided in [Appendix A](#))
 - For replacements or retrofits, complete [A.1](#) and [A.2](#). For new crossings, complete only [A.2](#).
- Hydraulic Performance Data Table (provided in [Appendix A](#))

- The applicable Conceptual Design Figure (provided in [Appendix B](#))
- Road-Stream Crossing Report (template provided in [Appendix C](#))

Preapplication meetings with relevant agencies are important when balancing the goals of a project with regulatory requirements, particularly for new crossings. These meetings can reduce back-and-forth between agencies, lead to a better stream crossing design, can result in faster construction time, and reduced project costs. RIDOT recommends the designer schedules a preapplication meeting with relevant agencies, specifically RIDEM and USACE, early in the design process to allow for comment on the project intent as early as possible.

4.1 Road-Stream Crossing Design Standards

The following road-stream crossing Design Standards were developed to provide cost-efficient, low maintenance and resilient road-stream crossings for Rhode Island. [Table 2](#) (below) outlines the Design Criteria requirements associated with the Design Standards (Base and Optimal) with further definitions and descriptions of each Criteria provided in [Section 4.2](#). The Standards apply to each of the Design Criteria categories, which are the categories that are impactful on the detailed design of a crossing structure and the project's decision-making process. Various scores from the [Assessment Handbook](#) can indicate which Design Criteria and Design Standards are most critical for re-design of existing crossings. The italicized language in [Table 2](#) specifies the applicable [Assessment Handbook](#) scores at which RIDOT recommends the Optimal Standard be met.

Section 4: Design Standards

Table 2: Overview of Road-Stream Crossing Design Standards

Design Criteria	Optimal Standards ⁴	Base Standards
<i>Design Approach</i>	<ul style="list-style-type: none"> USFS Stream Simulation. <i>Scaled Crossing Priority Score</i> >0.66 	<ul style="list-style-type: none"> AOP Design or Modified Hydraulic Design.
<i>Structure Type</i>	<ul style="list-style-type: none"> Bridge, 3-sided box culverts, open-bottom or arch culverts. <i>Binned Overall Geomorphic Impact Score</i> ≥3 	<ul style="list-style-type: none"> Pipe culvert or box culvert with embedment (see Embedment Criteria below).
<i>Channel Velocities</i>	<ul style="list-style-type: none"> Velocity within the swimmable range of target species or comparable to a reference reach at bankfull flow and range of base flows (if no target species). Must also include AOP study for target species (when applicable). <i>Binned Aquatic Passability Score</i> ≥3 	<ul style="list-style-type: none"> Velocity comparable to natural channel at bankfull flow.
<i>Climate Change</i>	<ul style="list-style-type: none"> Design for sea level rise and/or increased precipitation projections based upon Hydraulic Design Requirements (see <i>Table 3</i>). 	
<i>Crossing Profile</i>	<ul style="list-style-type: none"> Crossing profile to match existing natural stream using reference reach and vertical adjustment potential (VAP). <i>Binned Aquatic Passability Score</i> ≥3 	<ul style="list-style-type: none"> Crossing profile to match existing natural stream grade upstream and/or downstream of the crossing location
<i>Embedment, Substrate, and Channel Stability</i>	<ul style="list-style-type: none"> 1 foot (minimum) of natural substrate material above any required scour protection material. Channel cross section within the crossing designed to mimic low flow depths of natural channel. Include grain size analysis and bed mobility/scour stability analysis. <i>Binned Overall Geomorphic Impact Score or Binned Aquatic Passability Score</i> ≥3 	<ul style="list-style-type: none"> Natural bottom substrate greater than or equal to (≥) 2 feet for all structures ≥ 8 feet in span; ≥ 25% of opening height for all spans less than 8 feet. Channel cross section designed within the crossing to mimic low flow depths of natural channel.
<i>Hydraulic Modeling</i>	<ul style="list-style-type: none"> HEC-RAS (or equivalent) analysis required. See <i>Table 3</i> for hydraulic design requirements. <i>Binned Transportation Disruption Score</i> ≥3 	<ul style="list-style-type: none"> HY-8, CulvertMaster, HydroCAD, (or equivalent) analysis required. See <i>Table 3</i> for hydraulic design requirements.
<i>Openness Ratio</i>	<ul style="list-style-type: none"> Openness ratio ≥ 1.64 feet and height ≥ 6 feet. If conditions significantly inhibit wildlife, use openness of ≥ 2.46 feet and height ≥ 8 feet. <i>Binned Aquatic Passability Score</i> ≥4 	<ul style="list-style-type: none"> Openness ratio ≥ 0.82 feet to the maximum extent practicable.
<i>Stream Crossing Span</i>	<ul style="list-style-type: none"> Hydraulic span ≥ 1.2 x BFW with banks on both sides designed for applicable wildlife passage. <i>Binned Flood Impact Potential Score</i> ≥3 	<ul style="list-style-type: none"> Hydraulic span ≥ 1.2 x BFW with banks on both sides.
<i>Structural Stability</i>	Design in accordance with Rhode Island and AASHTO LRFD standards. Structural design includes appropriate loading including streamflow, span configuration and freeboard, wingwall layout and design, and footing design. Hydraulic modeling and geotechnical analysis provide direction on foundation requirements and site-specific scour mitigation measures.	
<i>Tidal/Coastal Modeling</i>	<ul style="list-style-type: none"> Velocity comparable to natural channel during the ebb and flow for high tide or maximum flow conditions and low tide/low flow conditions using a detailed unsteady hydraulic modeling analysis with an accompanying AOP study.⁵ <i>Binned Climate Change Vulnerability Score</i> ≥3 	<ul style="list-style-type: none"> Designed to accommodate the exchange of the full tidal prism using a simplified quantitative analysis (i.e. spreadsheet).⁵
<i>Reporting Requirements</i>	<ul style="list-style-type: none"> Road-Stream Crossing Report (with H&H computations), Geotechnical Investigation, Road-Stream Crossing Standards Review Checklist(s), Hydraulic Performance Data Table, Conceptual Design Figure(s) 	

⁴ Italicized language indicates the *Assessment Handbook* score at which the Optimal Standards are recommended.

⁵ Replacing existing tidal crossings may unintentionally alter water surface elevations in previously restricted areas and create flooding hazards. This potential result should be analyzed for risk and regulatory compliance before upgrading a crossing.

Section 4: Design Standards

Table 3: Hydraulic Design Requirements

Highway Functional Classification ⁶	Flood Frequency Requirements ⁷	Design Storm Freeboard Requirements	Climate Change Projection Horizon ^{8,9,10}
<i>Span Less than 10 feet</i>			
<i>All Classes</i>	<ul style="list-style-type: none"> • Design Storm: 10% AEP • Design Scour: 4% AEP • Check Scour: 2% AEP • Climate Check: 4% AEP 	No freeboard required	Pass the design storm for the projections of the end of the service life: 75-year Horizon (unless crossing is atypical)
<i>Span 10 to 20 feet</i>			
<i>Rural Minor Collector</i> <i>Rural Local</i> <i>Urban Collector/Local Bike or Walking Path</i>	<ul style="list-style-type: none"> • Design Storm: 10% AEP • Design Scour: 4% AEP • Check Scour: 2% AEP • Climate Check: 4% AEP 	1-foot	Pass the design storm for the projections of the end of the service life
<i>Rural Major Collector</i> <i>Urban Minor Arterial</i>	<ul style="list-style-type: none"> • Design Storm: 4% AEP • Design Scour: 2% AEP • Check Scour: 1% AEP • Climate Check: 2% AEP 	2-feet	Pass the design storm for the projections of the end of the service life
<i>Rural Principal Arterial</i> <i>Rural Minor Arterial</i> <i>Urban Principal Arterial</i> <i>Or Any Structure on the NHS</i>	<ul style="list-style-type: none"> • Design Storm: 2% AEP • Design Scour: 1% AEP • Check Scour: 0.5% AEP • Climate Check: 1% AEP 	2-feet	Pass the design storm for the projections of the end of the service life
<i>Span 20 feet or Greater</i>			
<i>Bike or Walking Path</i>	<ul style="list-style-type: none"> • Design Storm: 10% AEP • Design Scour: 1% AEP • Check Scour: 0.2% AEP • Climate Check: 4% AEP 	1-foot	Pass the design storm for the projections of the end of the service life
<i>Rural Minor Collector</i> <i>Rural Local</i> <i>Urban Collector/Local Bike or Walking Path</i>	<ul style="list-style-type: none"> • Design Storm: 4% AEP • Design Scour: 1% AEP • Check Scour: 0.2% AEP • Climate Check: 4% AEP 	2-feet	Pass the design storm for the projections of the end of the service life
<i>Rural Major Collector</i> <i>Urban Minor Arterial</i>	<ul style="list-style-type: none"> • Design Storm: 4% AEP • Design Scour: 1% AEP • Check Scour: 0.2% AEP • Climate Check: 2% AEP 	2-feet	Pass the design storm for the projections of the end of the service life
<i>Rural Principal Arterial</i> <i>Rural Minor Arterial</i> <i>Urban Principal Arterial</i> <i>Or Any Structure on the NHS</i>	<ul style="list-style-type: none"> • Design Storm: 2% AEP • Design Scour: 1% AEP • Check Scour: 0.2% AEP • Climate Check: 1% AEP 	2-feet	Pass the design storm for the projections of the end of the service life

⁶ All Rhode Island Department of Transportation roadways are categorized based on the Highway Functional Classification, available from the Rhode Island Division of Statewide Planning.

⁷ The Climate Check Event is only necessary if precipitation projections are not available for Rhode Island. If the Climate Check Event is utilized, the project must pass the Climate Check flood. If location specific flood discharges or precipitation projections become available for Rhode Island, projections shall be utilized according to the project’s Climate Change Projection Horizon.

⁸ Climate Change projections often provide a range of scenarios for time horizons. RIDOT recommends the design utilizes the high (or equivalent) scenario at a minimum.

⁹ If exact future horizon year is not available, round to the nearest 10.

¹⁰ Projection Horizon based upon planned construction year.

Section 4: Design Standards

Table 3 describes the hydraulic capacity requirements for all crossings.

New, replacement, and retrofit projects for riverine and tidal crossings, regardless of meeting the Base or Optimal Standards, must meet the hydraulic capacity requirements.

The hydraulic design terms used in *Table 3* are defined below:

- The **Design Storm** is the flood producing storm event (based upon the applicable AEP) used to determine the required hydraulic capacity of a crossing, with the inclusion of freeboard.
- The **Design Scour** and **Check Scour** events are the flood producing storm events that the crossing's foundations, abutments, or piers must be designed to withstand, in accordance with the RIDOT Load and Resistance Factor Design (LRFD) Bridge Design Manual (2007).
 - **Note for new crossings with spans greater than 20-feet:** Refer to the RIDOT Load and Resistance Factor Design (LRFD) Bridge Design Manual (2007): *New crossings may not use riprap or other scour countermeasures as a means of scour protection and must have foundations designed to withstand the conditions of scour for the design scour event and the check scour event.*
- The **Climate Check** event is the flood producing storm event used to determine the required hydraulic capacity of a crossing to account for climate change as part of the design; **the climate check event is only necessary if precipitation projections are not available for Rhode Island.**

4.1.1 Conceptual Design Guidance

This Manual provides Conceptual Design Figures in *Appendix B* that show profile views for four typical crossing types and illustrate some of the Design Standards that are described below. These design concepts are intended to aid the designer in

determining key hydraulic design features. The figures are not intended to be used as a template for design, design plans, or final project deliverables. The figures do not represent structural, highway, or geotechnical features which may need to be considered. The typical crossing types also include a Hydraulic Features Table, which assists designers in conveying the key variables related to hydraulic modeling. **The applicable Conceptual Design Figure (including the completed Hydraulic Features Table) must be provided as part of the 30% Design Submission to the RIDOT Environmental Division.** Of the four Conceptual Design Figures provided in *Appendix B*, the designer should choose the figure that most similarly represents their crossing. If the provided Conceptual Design Figures do not address the key hydraulic features of the proposed crossing, such as piers or multiple openings, additional narrative or an equivalent figure must be provided to RIDOT Environmental Division for review and approval.

4.2 Design Criteria

The Design Criteria are the topics that engineering experience has shown to be impactful on the detailed hydraulic design of a crossing structure, the project decision making process, and which guide the industry standards. This section elaborates on each of the Design Criteria provided in *Table 2* and *3* above. Road-stream crossing designers must review each Design Criteria below for a complete understanding of each topic. Designers must also complete the Road-Stream Crossing Standards Review Checklist and Hydraulic Performance Data Table provided in *Appendix A* after reviewing this section. For replacements or retrofits, designers must complete checklist *A.1* (Existing) and *A.2* (Proposed). For new crossings, designers only need to complete checklist *A.2*. **The Road-Stream Crossing Standards Review Checklist(s) and Hydraulic Performance Data Table must be included as part of the 30% Design Submission to the RIDOT Environmental Division.**

Section 4: Design Standards

4.2.1 Design Approach

To achieve the Optimal Standard, a crossing must be designed using the Stream Simulation approach outlined by the U.S. Forest Service (FSSWG, 2008). Stream Simulation is the preferred design approach for road-stream crossings because it is most likely to allow for unrestricted movement of aquatic and terrestrial species and mimic characteristics similar to the natural channel. To achieve the Base Standard, a crossing must be designed using AOP Design or Modified Hydraulic Design, discussed in detail in [Section 3](#).

An existing crossing with a high (>0.66) Scaled Crossing Priority Score ([Assessment Handbook: Section 13](#)) indicates an existing crossing creates a significant barrier to AOP and/or is more likely to fail. RIDOT recommends that existing crossings with a Scaled Crossing Priority Score >0.66 meet the Optimal Design Approach Standard by using the Stream Simulation approach to provide greater overall benefits related to flood resiliency and stream continuity.

4.2.2 Structure Type

To achieve the Optimal Standard, a bridge or open-bottom structure must be used to minimize impacts to stream geomorphology, sediment and debris transport, organism passage, and maintain the natural channel bed. An open-bottom structure spanning the stream and its banks is considered the preferred Optimal Standard because it maintains the original natural channel bed with limited alteration or disturbance. Depending on the span of the crossing, the structure may also accommodate valley and floodplain processes during the most extreme hydraulic events. To achieve the Base Standard, a crossing structure can be a pipe or box culvert with sufficient embedment of natural substrate (see [Section 4.2.6](#)). If possible, a crossing structure must maintain natural stream banks within the crossing (original banks or reconstructed) including wildlife benches for semi-aquatic and terrestrial animal passage. See [Section 4.2.9](#) for further discussion of

wildlife bench recommendations. For crossings located on a smaller (less than 10 feet), rural roads, guardrail should be considered to prevent car wash-out during more frequent overtopping events.

An existing crossing with a Binned Overall Geomorphic Impact Score ≥ 3 ([Assessment Handbook: Section 8](#)) indicates that a crossing is currently impacting or has a high potential to impact geomorphic processes that threaten the structure itself, other adjacent infrastructure, or aquatic organism passage. RIDOT recommends that existing crossings with a Binned Overall Geomorphic Impact Score ≥ 3 meet the Optimal Structure Type Standard as the structure and surrounding area will likely significantly benefit from an open bottom that allows for natural geomorphic processes.

4.2.3 Channel Velocities

To achieve the Optimal Standard, the flow velocities at a crossing must be within the swimmable range of the target aquatic species present in the channel. If there are no applicable aquatic target species within the waterway, the flow velocities at a crossing must be comparable to the reference reach channel at bankfull flow and range of baseflows to achieve the Optimal Standard. When a target aquatic species is known, the Optimal Standard requires an AOP study, which at a minimum compares the swimming velocities of any known species to base flow velocities of the proposed design. Specially, the maximum flow velocity at the crossing during baseflows must be swimmable by the weakest target species during migration periods. An AOP study is required within defined cold-water fisheries, diadromous fish habitat, or when otherwise required by the RIDOT Environmental Division. The swimming speeds of common [Atlantic Coast diadromous fish species](#) are included in [Appendix F](#) (Turek et al., 2016).

To achieve the Base Standard, the flow velocity within a stream crossing must be comparable to the natural channel at bankfull flow and a range of baseflows and

Section 4: Design Standards

does not require an AOP study. Regardless of the level of standard achieved, the channel must be designed with a five-point cross section to mimic low flow depths of the natural channel, further discussed in [Section 4.2.6](#) below. Maintaining natural channel velocities that support aquatic organism passage also allows for the movement of sediment and debris for increased habitat continuity. Channel velocities also impact the channel stability and structural stability as a factor for potential scour. See [Section 4.2.10](#) for further discussion of structural stability design criteria.

4.2.4 Climate Change

[Table 3](#) describes the requirements for accounting for climate changes as part of the crossing design. This Manual requires the proposed design to pass the future Design Storm according to the span and the highway functional classification of the roadway (i.e., frequency and type of road use). Climate change projections are updated as frequently as every year, and therefore, the most recent applicable information available should be used to meet the future hydraulic requirements of a stream crossing. The designer must research and utilize the most applicable and up-to-date sea level rise (if tidally influenced) and increased precipitation projections for the project location. This Manual provides the required projection horizon to be used for sea level rise or precipitation projection data. A projection horizon is how far ahead in the future the crossing must be designed to, based upon the planned construction year. For example, if the crossing is a 15-foot span Rural Major Collector with a planned construction year of 2025 and a service life of 75-years, then the Climate Change Projection Horizon is 75-years, and the designer must find the most applicable and up-to-date sea level rise and increased precipitation projections for the year 2100 and design the crossing to pass the 2100 4% AEP tidal event (if tidally influenced) and the 2100 4% AEP precipitation event. This Manual assumes the crossing service life of culverts and bridges to be 75-years, based upon the American Association of State Highway and Transportation Officials (AASHTO) LRFD Bridge Design

Specifications (2020). If a crossing is atypical (e.g., a temporary bridge or structure specifically designed for a longer service life), then the designer may use and alternate service life.

At the time of this Manual publication, there are no Rhode Island specific projections for increased precipitation. As such, this Manual has developed an alternate approach to account for increased precipitation due to climate change based upon the studies completed in the surrounding region. If location specific precipitation projections become available for Rhode Island, then the designer must design based on the Climate Change Projection Horizon provided in [Table 3](#). Under the condition that no Rhode Island specific projections for increase precipitation are available, the crossing must be designed to pass the Climate Check Event according to the span and highway functional classification of the roadway provided in [Table 3](#).

The Climate Check Event is based upon the review of other regional approaches to climate change and precipitation changes. RIDOT reviewed the approach by New York State to downscale projections of extreme rainfall and Massachusetts Department of Environmental Protection (MassDEP)'s approach, known as NOAA14 PLUS. The New York State approach is based upon downscaled projections of future global extreme rainfall, modified for the New York region (DeGaetano, 2017). The NOAA14 PLUS approach utilizes the upper limit of the current day NOAA Atlas 14 precipitation depths multiplied by 90% for future storm depths (MassDEP, 2020). The Climate Check Events provided in [Table 3](#) align with the determinations of both approaches.

Below is a list of reputable sea level rise and precipitation projection sources that should be included in the designer's research:

- Rhode Island Coastal Resources Management Council (RI CRMC)

Section 4: Design Standards

- [Coastal Hazard Application Worksheet and Online Viewer](#)
- The State of Rhode Island Climate Change Office
- National Oceanic and Atmospheric Administration (NOAA)
- Northeast Climate Adaptation Science Center (NECASC)
- Intergovernmental Panel on Climate Change (IPCC)

Climate Change projections often provide a range of scenarios for time horizons. RIDOT recommends the design utilizes the high (or equivalent) scenario at a minimum. Other applicable sea level rise and precipitation projection sources may be used if available after the publication of this Manual. If a crossing is not in a tidally influenced area (see Tidal/Coastal Modeling below), only precipitation changes need to be considered.

4.2.5 Crossing Profile

To achieve the Optimal Standard, the crossing profile design must be based on a suitable reference reach that the designer has determined to be naturally stable based on the morphology (FSSWG, 2008). The profile must be designed using the vertical adjustment potential (VAP). The VAP is range of potential vertical

streambed adjustment (due to erosion or deposition). The upper and lower VAP lines represent respectively the highest and lowest likely elevations of any point on the streambed surface (FSSWG, 2008). See [Figure 4-1](#) for an example below. By matching the vertical profile of a crossing structure to the natural stream, the structure has a greater likelihood of achieving similar flow velocities of the natural channel and accommodating bed material movement and future bed profiles. This may require adjustment of the existing inlet and outlet elevations, and potentially grading upstream and downstream of the crossing to match the slope of the reference reach. The horizontal profile of the crossing must also match the existing stream and banks to ensure slope stability and allow for AOP. To achieve the Base Standard, the road-stream crossing profile must match the existing natural stream grade upstream and/or downstream of the crossing location, but does not require use of a reference reach or determining the VAP.

For replacement crossing projects, further evaluation is needed to provide a design that will not disrupt stream stability and potentially cause unstable vertical profile movement. In certain locations, matching the natural stream profile may not be possible and should match to the maximum extent practicable, with approval from the RIDOT Environmental Division.

Figure 4-1: The vertical adjustment potential (VAP) for a uniform streambed profile

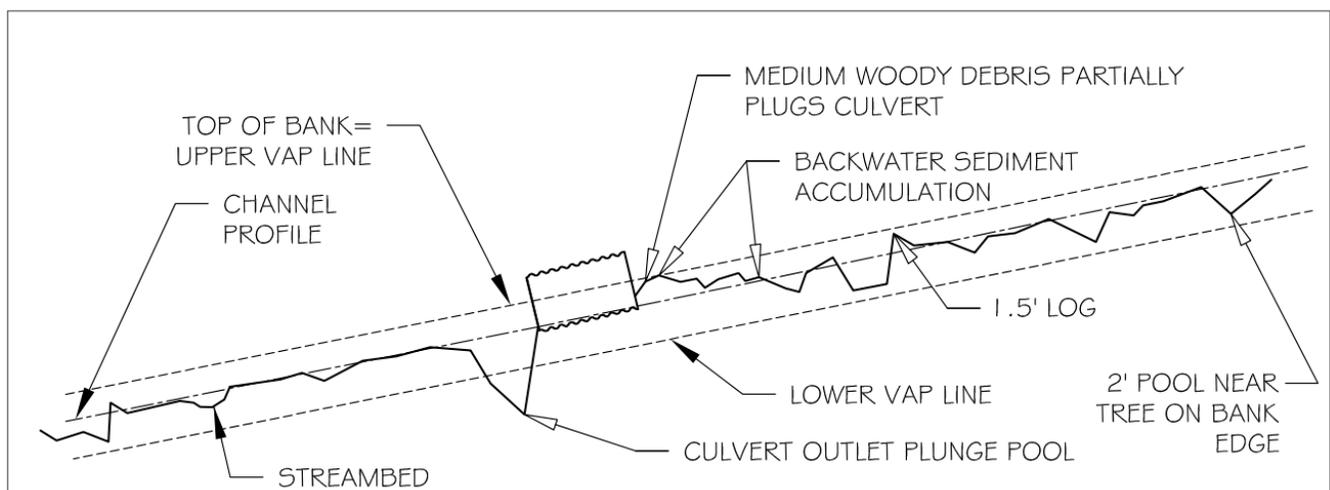

© FSSWG, 2008

Section 4: Design Standards

An existing crossing with a *Binned Aquatic Passability Score* ≥ 3 (*Assessment Handbook: Section 12*) indicates that a crossing creates a moderate to severe barrier for AOP that can be caused by issues relating to the crossing profile. RIDOT recommends that existing crossings with a *Binned Aquatic Passability Score* ≥ 3 meet the Optimal Crossing Profile Standard by redesigning the crossing to match the longitudinal profile of the natural stream channel at a reference reach, so long as this can be done without impacting the overall stream stability.

4.2.6 Embedment, Substrate, and Channel Stability

To achieve the Optimal Standard, all open-bottom crossing structures must have a minimum of 1 foot of natural substrate material above any required scour protection material and must include a grain size analysis and bed mobility/scour stability analysis. If there are target aquatic species present in the waterbody, the minimum flow depth during baseflows must also be at least 1.5 times the maximum body height of the largest target aquatic species to allow for species migration. The minimum recommended channel depths for common *Atlantic Coast diadromous fish species* are included in *Appendix F* (Turek et al., 2016). To achieve the Base Standard, all closed-bottom crossings greater than or equal to 8 feet in span must have a minimum embedment of 2 feet and crossings less than 8 feet in span must have a minimum embedment of 25% of the opening height. The channel cross section within the crossing must be designed to mimic low flow depths of natural channel.

Embedment with natural substrate in a crossing structure is based on the Stream Simulation design approach and allows for natural movement of bedload and formation of a stable bed inside the stream crossing without exposing or undermining the crossing structure. Embedment also provides adequate ecosystem connectivity and wildlife accessibility to both sides of the stream crossing. The

substrate within all stream crossings must match the characteristics of the natural stream channel and the banks (mobility, slope, stability, confinement, grain and rock size) to ensure materials will migrate naturally under normal flow conditions. For new closed-bottom crossings (e.g., a pipe/box culvert), the natural channel substrate should be set aside during construction and placed or washed back into the structure upon completion. When completing hydraulic modeling for an embedded crossing, the hydraulic opening of the crossing should be the opening height, minus the embedment depth. For example, if a proposed culvert is 6 feet in height with 2 feet of embedment, the hydraulic opening in the model should be 4 feet. Hydraulic modeling and geotechnical analysis provide direction on foundation requirements and site-specific scour mitigation measures.

Grain size analysis and bed mobility/scour stability analysis for streambed material (not foundation material) should be performed based on guidance outlined by the FHWA's Hydraulic Engineering Circular Nos. 18 (HEC-18), HEC-20, HEC-23, and HEC-25 (2012; 2012; 2009; 2008). The designer should also review the NCHRP abutment scour approach and the HEC-14 guidance for energy dissipators for culverts (Ettema et al., 2010; FHWA, 2006). *Figure 4-2* below illustrates recommended geotechnical sampling locations. Recommended sample locations may vary based upon the crossing opening design (see "Project Dependent Overbank Geotechnical Sample" on *Figure 4-2*). At a minimum, the designer must obtain the "Recommended Geotechnical Sample" locations upstream of the crossing, downstream of the crossing (as shown on *Figure 4-2*), and the upstream face of piers. Depending on the needs of the scour analysis, the geotechnical analysis should determine the grain size of the D_{16} , D_{50} , and D_{84} based upon the American Society for Testing and Materials (ASTM) D6913, D7928 standards (or AASHTO T88), or USFS Pebble Count. The samples should obtain the erodible subsurface material immediately below any armor layer.

Section 4: Design Standards

In accordance with the RIDOT LRFD Bridge Design Manual, new crossings with spans greater than 20 feet cannot use riprap or other scour countermeasures as a means of scour protection; all foundations, piers, or abutments must be designed to withstand the conditions of scour for the design flood and the check flood (2007).

Figure 4-2: Recommended Soil Samples Locations

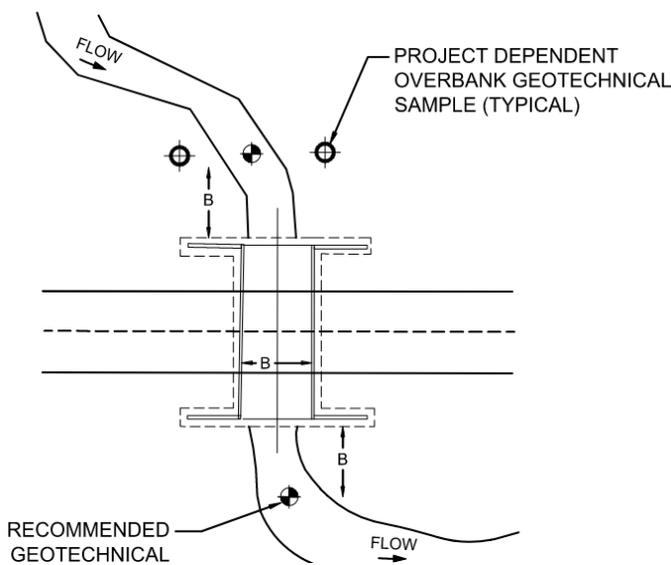

Many aquatic organisms travel during low flow conditions accommodated by a five-point cross section, see [Figure 4-3](#) below. The embedment and substrate of the proposed channel must be designed and constructed to mimic the natural channel cross section shape and low flow depths and velocities for both Optimum and Base Standards. As described above, the minimum flow depth at the channel thalweg must be at least 1.5 times the body height of the largest target species to achieve the Optimal Standard.

Figure 4-3: Five Point Cross Section

Typical Hydraulic Section

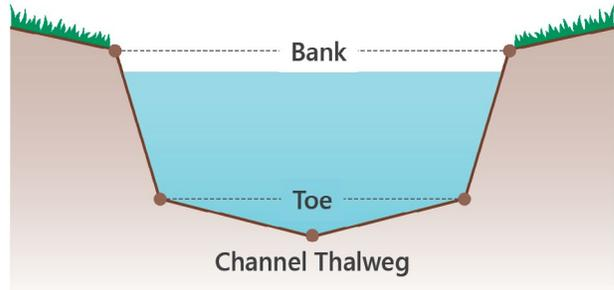

If the project includes the replacement of an existing structure and/or substructure which interferes with the proposed design, such as existing piers, abutments or wingwalls, the existing structure and/or substructure must be removed to 2 feet below the streambed (or natural ground surface) at that location or below VAP line, whichever elevation is lower.

An existing crossing with a *Binned Aquatic Passability Score* ≥ 3 ([Assessment Handbook: Section 12](#)) indicates a crossing may have partial or no substrate coverage or the substrate does not match the characteristics of the natural streambed. Additionally, if an existing crossing has a *Binned Overall Geomorphic Impact Score* ≥ 3 ([Assessment Handbook: Section 8](#)) the crossing may significantly benefit from upgrade to an open-bottom structure to allow for natural geomorphic processes and would maintain the natural channel substrate. RIDOT recommends that crossings with a *Binned Aquatic Passability Score* ≥ 3 or a *Binned Overall Geomorphic Impact Score* ≥ 3 meet the Optimal Standard by using open-bottom crossing structures with ≥ 1 foot of natural substrate material above any required scour protection material and by including a grain size and bed mobility/scour stability analysis.

Section 4: Design Standards

4.2.7 Hydraulic Modeling

To achieve the Optimal Standard, the designer must model the hydraulic capacity using U.S. Army Corps of Engineers' (USACE) Hydrologic Engineering Center—River Analysis System (HEC-RAS) or conduct an equivalent riverine analysis. The analysis must evaluate any potential downstream impacts when replacing an existing culvert with a new design, which may cause flooding, erosion, or failure of downstream structures. To achieve the Base Standard, the hydraulic capacity of a proposed crossing can be modeled with programs such as HydroCAD, CulvertMaster, or HY-8 Culvert Hydraulic Analysis Program, or equivalent software. The hydraulic analysis must utilize an applicable rainfall-runoff model, regional flood-flow regression equations, or statistical analysis of peak-flow records at representative stream gages to determine associated flood flows at the crossing. Detailed steps for determining hydrologic inputs using StreamStats and other appropriate methods to estimate peak flows are summarized in the *Assessment Handbook: Section 5.3*. When precipitation inputs are required, the designer must use best available data and confirm compliance with RIDEM Section 250-RICR-105-10 Part 8—Stormwater Management, Design and Installation Rules. At the time of publication of this Manual, RIDEM requires precipitation data to be sourced from Cornell University's Northeast Regional Climate Center (NRCC).

At existing crossings, the hydraulic analysis must model flows through the existing and proposed crossing to confirm the proposed structure will not worsen flow or velocity conditions. The results from this analysis can be used to identify the required structure size and configuration, as well as channel modifications that are required to protect the structure and adjacent infrastructure from damage during high flow events. The velocity results from the hydraulic analysis are used to confirm flows within the crossing are within the swimmable range of target species (see *Section 4.2.3*. Channel Velocities).

All structures must meet the minimum freeboard and design storm requirements based on the span and the highway functional classification as shown in *Table 3*. If a project is unable to meet requirements outlined in *Section 4.1* and in *Table 3* based on the project's specific needs and constraints, the project may pursue a waiver with the approval of the RIDOT Environmental Division. The crossing structure must also comply with any applicable Federal Emergency Management Agency (FEMA) requirements for floodplain areas, including evaluation of potential effects to the base flood and associated floodway elevations (referred to as a "No-Rise Certification").

An existing crossing with a *Binned Transportation Disruption Score* ≥ 3 (*Assessment Handbook: Section 11*) is at a roadway that likely serves as a hurricane evacuation route, E-911 primary route, or is a principal arterial or high-traffic roadway. RIDOT recommends that existing crossings with a *Binned Transportation Disruption Score* ≥ 3 meet the Optimal Hydraulic Design Standard by modeling the existing and proposed crossing with HEC-RAS (or equivalent analysis) and by meeting the hydraulic requirements listed in *Table 3*.

4.2.8 Openness Ratio

To achieve the Optimal Standard, a crossing structure must have an openness ratio greater than or equal to (\geq) 1.64 feet and a height ≥ 6 feet. If conditions significantly inhibit wildlife passage, such as roads with frequent deer-vehicle collisions, designers must achieve an openness ratio ≥ 2.46 feet and a height ≥ 8 feet¹¹ (River and Stream Continuity Partnership, 2001). To achieve the Base Standard, a crossing structure must have an openness ratio ≥ 0.82 feet to the maximum extent practicable.

11 Openness standards for larger terrestrial passage are primarily based on a study by Reed et al. in 1979, which concluded that 0.6 meters (2.0 feet) is the minimum openness needed for mule and whitetail deer to use a structure.

Section 4: Design Standards

Openness is the cross-sectional area of a structure opening (not including the embedded area) divided by its crossing length. See [Equation 4-1](#) below:

Equation 4-1

$$\text{Openness Ratio} = \frac{\text{Cross Section Area}}{\text{Length}}$$

The goal of achieving the Base or Optimal Openness Ratio Standard for a stream crossing is to provide dry passage for semi-aquatic and small terrestrial wildlife.¹² Greater openness not only allows larger animals to pass through the structure but creates adequate natural illumination, increasing the likelihood animals will use the crossing for passage. Structures that meet the Base or Optimal Openness Ratio Standard are also more likely to pass flood flows and woody debris that would otherwise obstruct water passage.

An existing crossing with a *Binned Aquatic Passability Score* ≥ 4 ([Assessment Handbook: Section 12](#)) indicates that a crossing creates a significant to severe barrier for AOP. RIDOT recommends that existing crossings with a *Binned Aquatic Passability Score* ≥ 4 meet the Optimal Openness Ratio Standard to improve wildlife passage and accommodate larger terrestrial and semi-aquatic species.

4.2.9 Stream Crossing Span

To achieve the Optimal Standard, the crossing structure must have a hydraulic span of a minimum of 1.2 times the natural bankfull width (BFW) with banks on both sides designed to allow for dry passage of semi-aquatic

and terrestrial wildlife.¹³ The bankfull flow and width of a stream should be determined based on the methodology outlined in the [Assessment Handbook: Section 3.5.2](#). To achieve the Base Standard, the crossing structure must have a hydraulic span of a minimum of 1.2 times the natural BFW with defined banks on both sides. For the Base Standard, however, the banks within the structures do not need to be specifically designed for semi-aquatic and terrestrial wildlife (see specifics on wildlife bench design below) but must be constructed at the same slope and elevation of the upstream and downstream banks, such that there is clear connectivity. See [Equation 4-2](#) below:

Equation 4-2

$$\text{Span} = 1.2 \times \text{BFW}$$



Example of bridge spanning the natural banks to allow for floodplain processes on the Woonasquatucket River

¹² The United States Army Corps of Engineers New England District, Connecticut, Maine, Massachusetts and New Hampshire all require or recommend the same minimum openness ratio (≥ 0.82 feet) (U.S. Army Corps of Engineers, 2015; Connecticut Dept. of Environmental Protection, 2008; Greenwood, 2017; Massachusetts Department of Fish and Game Division of Ecological Restoration, 2018; University of New Hampshire, 2009).

¹³ This design criterion was first introduced in Washington State in 2003 and based on a study that observed structures 1.3 times the channel BFW to replicate natural stream processes and create similar passage conditions (Barnard, 2003). Similarly, wide-spanning culverts and open-bottom structures with widths greater than the natural BFW were found to provide a buffer against lateral and vertical stream adjustments (Bates, 2003). Many states and agencies have since found that using a span of 1.2 times BFW, compared to Barnard's result of 1.3, is sufficient to replicate natural stream processes and permit organism passage (Connecticut Dept. of Environmental Protection, 2008; Greenwood, 2007; Massachusetts Department of Fish and Game Division of Ecological Restoration, 2018; National Marine Fisheries Service, 2018).

Section 4: Design Standards

Crossings should aim to span the natural channel and minimize surrounding disturbance. The designer should balance these two goals by shortening and aligning the crossing perpendicular to a straight segment of the stream channel or by skewing the crossing alignment to mimic the stream alignment. RIDOT recommends the designer follow Chapter 6 of the USFS Stream Simulation to provide the most resilient design for the stream and associated wildlife (FSSWG, 2008). The USFS Stream Simulation Design Approach is the requirement for the Optimal Standard of the Design Approach (summarized in [Section 3.1](#) and [Table 2](#)). [Figure 4-4](#) presents three alignment options for the most common alignment challenge, where the road is at an acute angle to the stream channel:

As shown in [Figure 4-4](#) Option C, there are cases where the best way to accommodate the stream alignment and reduce span length is to widen the crossing. This may result in a crossing that is larger than 1.2 times the bankfull width. Of the options above, Option B entails the greatest risk to channel instability by altering the natural streamflow path.



Example of wildlife bench ©Minnesota Department of Natural Resources

Properly designed wildlife benches can significantly improve road safety by reducing the number of animal-vehicle collisions (Peterson & McAllister, 2013). The following language details best practices for the design of wildlife benches:

- If feasible given the crossing span, wildlife benches should be a minimum of 3 feet wide and should be slightly above the bankfull elevation to prevent wash-out (Minnesota DNR, 2014).

continued on next page

Figure 4-4: Alignment options for crossing where the road crosses the stream at an acute angle

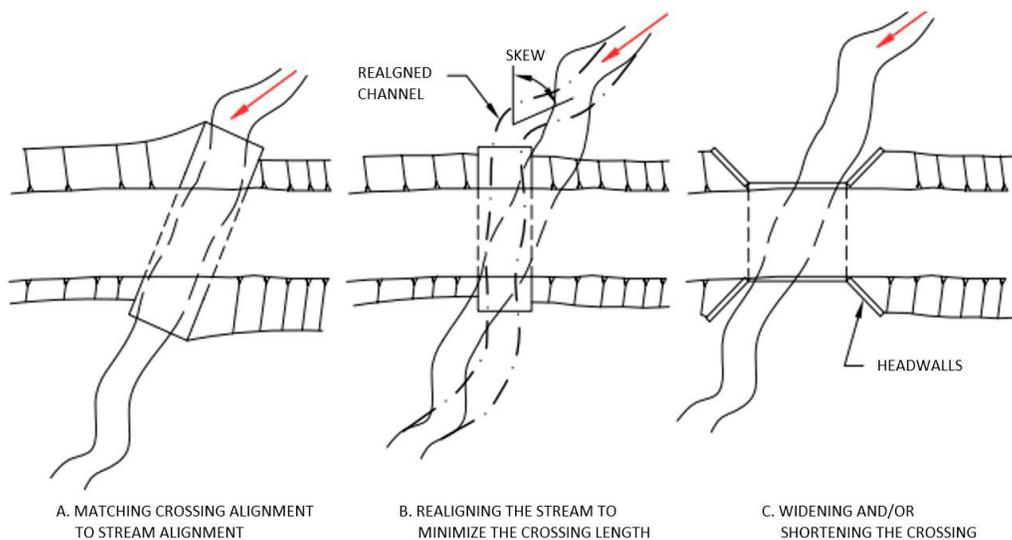

© Image adapted from USFS Stream Simulation (FSSWG, 2008)

Section 4: Design Standards

- The wildlife benches should be graded to meet the existing banks upstream and downstream of the crossing and should consist of native bank material and vegetation, whenever feasible.
- Native seeding or planting is particularly important on steep slopes near wildlife benches for reducing erosion and can provide shade, moisture, and cover for species. If the wildlife benches are constructed of larger stones or riprap for structural purposes, smaller material that is similar to the natural channel banks should be used to fill in the voids to create a walkable surface for wildlife passage, especially for hoofed animals and smaller species (e.g. non-stream dwelling salamanders).
- A stream crossing's value as a wildlife underpass can be further increased when fencing is constructed in a way that funnels animals into the crossing structure. This has been determined to be a very cost-effective method in reducing animal-vehicle collisions (Clevenger et al., 2001; Huijser et al., 2007). However, the fencing may not always be appropriate for a project site and should be evaluated for potential impacts to a floodway for example. Additional wildlife fencing information and design elements may be found in the FHWA Wildlife Crossing Crossing Structure Handbook (Clevenger and Huijser 2011).
- For projects where new abutments are placed behind existing abutments that are infeasible to remove, the existing abutment surface can be cut to the appropriate elevation and covered with natural bank material to encourage wildlife passage.
- The wildlife bench design should also consider height of the animal for which it's designed. For example, roads in areas with significant deer populations should be designed with appropriate clearance to accommodate the height of deer, if feasible given the stream and roadway elevations.

An existing crossing with a *Binned Flood Impact Potential Score* ≥ 3 (*Assessment Handbook: Section 10*) indicates that if the crossing fails, it's likely there will be severe impacts on existing infrastructure upstream and downstream of the crossing. These crossings usually constrict the natural channel or are in highly developed areas. RIDOT recommends that existing crossings with a *Binned Flood Impact Potential Score* ≥ 3 meet the Optimal Standard of 1.2 times BFW with wildlife benches on both sides to allow for natural floodplain processes and terrestrial and semi-aquatic wildlife passage.

4.2.10 Structural Stability

All crossing structures must be designed in accordance with RIDOT and AASHTO LRFD standards. A crossing's structural design accounts for appropriate loading, span configuration, wingwall layout and design, and footing design. Hydraulic modeling and geotechnical analysis provide direction on foundation requirements and site-specific scour mitigation measures.

All existing crossings must be designed in accordance with the RIDOT and AASHTO standards. *The Binned Structural Condition Score* (*Assessment Handbook: Section 10*) may indicate areas of structural failure that must be closely examined and/or analyzed in more detail during the re-design process.

4.2.11 Tidal/Coastal Modeling

To achieve the Optimal Standard, tidally influenced crossings must have velocities comparable to the natural channel during the ebb and flow during high tide or maximum flow conditions and low tide/low flow conditions using a detailed hydraulic modeling analysis, such as an unsteady HEC-RAS model (or equivalent) with the inclusion of an AOP study. To achieve the Base Standard, tidally influenced crossings must be designed to accommodate the exchange of the full tidal prism without significant restriction using a simplified quantitative volume analysis (e.g., spreadsheet). Designers should also be aware that tidally influenced crossings experience greater variability in water levels,

Section 4: Design Standards

velocity, salinity, dissolved oxygen, temperature, and pH compared to non-tidal crossings. Tidally influenced crossings, like all other crossing structures, must meet the hydraulic requirements in [Table 3](#), including freeboard. The designer may need to determine which water inflow (tidal or riverine) source governs the flow through the crossing, to choose the appropriate standards and modeling method.

Many existing tidal crossings currently restrict flow and therefore limit upstream water surface elevations. Replacing tidal crossings that restrict flow may unintentionally alter water surface elevations, jeopardize valuable habitats, or create flooding hazards. The introduction of salt water in areas where flow was previously restricted must be evaluated based on the project goals. Natural tidal flushing may be desired for some projects but may also cause marsh migration, changes in animal habitats or behavior (e.g. shorebird nesting areas), and saltwater intrusion. These potential impacts must be analyzed for risk and regulatory compliance before upgrading a crossing.

A crossing is considered tidally influenced if it is presently located waterward of the Rhode Island Mean Higher High Water (MHHW) line. To determine if a crossing is tidally influenced, the crossing location can be compared to the MHHW line from the Rhode Island Geographic Information System (RIGIS) open GIS data distribution clearinghouse or by using the StormTools application from the Rhode Island Coastal Resources Management Council ([Assessment Handbook: Section 2.3.2](#)). Tidal data for stations in Rhode Island is available from NOAA's Tides and Currents website. As discussed in [Section 4.2.4](#) Climate Change and [Table 3](#), sea level rise projections must be considered for all crossings.

An existing crossing with a *Binned Climate Change Vulnerability Score* ≥ 3 ([Assessment Handbook: Section 7](#)) indicates the crossing is undersized for future climate conditions, including peak flow rates, sea level rise, and storm surge. RIDOT recommends that existing

crossings with a *Binned Climate Change Vulnerability Score* ≥ 3 meet the Optimal Tidal/Coastal Modeling Standard using a detailed hydraulic modeling analysis.

4.2.12 Reporting Requirements

The following submittals are required as part of the RIDOT 30% Design Submission for all road-stream crossings to be reviewed and approved by RIDOT Environmental Division:

- Geotechnical Investigation
- Hydrologic and Hydraulic Computations
- Road-Stream Crossing Standards Review Checklist (provided in [Appendix A](#))
 - For replacements or retrofits, complete [A.1](#) and [A.2](#). For new crossings, complete only [A.2](#).
- Hydraulic Performance Data Table (provided in [Appendix A](#))
- The applicable Conceptual Design Figure (provided in [Appendix B](#))
- Road-Stream Crossing Report (template provided in [Appendix C](#))

The Road-Stream Crossing Report must summarize the results of the H&H analysis for the proposed structure. The Road-Stream Crossing Report should also include an operation and maintenance (O&M) plan to ensure safety and proper function of the crossing over the structure's lifetime (e.g. inspection frequency, debris removal, regrading, etc.). All reports, drawings, and computations must be prepared and stamped by a Rhode Island Registered Professional Engineer. All crossings must be designed in accordance with the Reporting Requirements Standard in [Table 2](#), regardless of the scores from the [Assessment Handbook](#).

Section 4: Design Standards

4.3 Existing Crossing Upgrades: Replacements and Retrofits

Many existing road-stream crossings in Rhode Island were designed and installed without considering AOP and stream connectivity. The existing conditions and potential consequences from changes in flow should be examined prior to replacing or retrofitting a crossing. A common unintended consequence of upgrading a crossing that previously restricted flow is that a larger crossing may unintentionally raise water surface elevations downstream, potentially causing flooding hazards. This potential result must be analyzed for risk and regulatory compliance before upgrading a crossing. Upgrading a crossing may also cause headcutting upstream of the replaced crossing, as previously aggraded sediment becomes mobilized. The extent of potential headcutting should be determined as headcutting may travel upstream and can be substantial enough to affect buried infrastructure, destabilize streambanks, or modify aquatic habitats (FSSWG, 2008). If it is determined that the benefits of retrofitting or replacing a crossing are greater than the cost of the project, potential environmental consequences, and are within regulatory allowances, then the crossing should be upgraded.

An existing crossing with a *Hydraulic Capacity Score* of 5 (*Assessment Handbook: Section 6*) indicates the crossing should be replaced, not retrofitted. A score of 5 indicates a crossing is not capable of passing the 10% AEP storm event and a retrofit is unlikely to achieve the flood frequency requirements listed in *Table 3*. A *Binned Structural Condition Score* ≥ 3 also indicates a crossing is likely to fail during a flood event and may need replacement if repair or retrofit is not sufficient.

4.3.1 Replacement

Road-stream crossing replacement may include replacing a structure in-kind or redesigning the structure for improved performance. When replacement is desirable, the design must meet the Optimal Standards. If a replacement project is unable to meet Optimal

Standards due to project or site constraints, the project must be designed to the Base Standards or the Base Standards to the maximum extent practicable (MEP) with approval from the RIDOT Environmental Division.

A crossing should be replaced:

- If a crossing is structurally poor, degraded, or has failed
- If a crossing is undersized for the design flows listed in *Table 3*
- If a crossing cannot be retrofitted to allow wildlife passage
- If replacement will not impact critical wetlands or create flooding impacts

4.3.2 Retrofit

Road-stream crossing retrofit should be considered if an existing crossing meets (and would meet following the proposed retrofit) the flood frequency requirements based on the highway functional class (see *Table 3*). Retrofitting a crossing may include modifications to improve AOP such as grade controls, baffles, weirs, and other support structures. Slip-lining a culvert (inserting a new, smaller piece of pipe into the larger piece) is strongly discouraged because it reduces the openness ratio of the crossing and can exacerbate issues with fish and wildlife passage by increasing flow velocity and perching distance. Depending on the retrofit, the crossing may require more frequent maintenance activities to function as designed. The proposed retrofit design must still allow the crossing to meet the design requirements of *Table 2* and *3*.

A crossing should be retrofitted:

- If a crossing is structurally sound
- If a crossing is sufficiently sized for high flows, including future flows
- If a retrofit will allow wildlife passage
- If replacement will negatively affect critical wetlands or create flooding impacts

Section 4: Design Standards

4.4 Intermittent Streams

Intermittent streams, also called seasonal or ephemeral streams, have active flow during certain times of the year. The flow may occur when the water-table is seasonally high due to precipitation or snow melt, but there will not be flow during drier periods of the year. Road-stream crossings at intermittent streams must adhere to the same Design Standards in [Table 2](#) and [3](#) as any perennial crossing to the maximum extent practicable.

In some cases, it may be difficult to determine if a stream is intermittent. RIDEM considers a stream intermittent if it flows long enough each year to develop and maintain a defined channel. According to the USGS, watershed size and geology are the most important characteristics for determining a stream's status. The StreamStats application from USGS incorporates watershed size and geology into its calculations and can be used to determine the probability that a stream is intermittent or perennial (flows on a year-round basis). If a stream site's upstream drainage area is less than 0.50 square miles, the stream should always be classified as intermittent. If the upstream drainage area is between 0.50-1.00 square miles, the stream should be classified as intermittent, with one exception. If flow duration statistics from StreamStats at the stream location predict a flow rate greater than or equal to 0.01 cubic feet per second at the 99% flow duration rate, the stream is considered perennial, not intermittent (Bent & Steeves, 2006).

Intermittent streams located in small watersheds (<0.50 square miles) but with well-defined banks for determining the BFW, or streams illustrated as a Blue Line on USGS Quadrangle Topographic maps, should aim to meet the Optimal Standards. For intermittent streams without bank definition, the Design Standards must be met to the maximum extent practicable with approval from the RIDOT Environmental Division

Section 5: Permitting Agencies

This section of the Manual provides a brief overview of the potential agencies that require review or permitting for a stream crossing project. As discussed previously, this Manual is not intended to guide the user through permits that may be required for each project. See the *Assessment Handbook: Section 14.3* for additional guidance. *Table 4* below provides a list of regulatory agencies that may require a project to be reviewed or obtain a permit:

Table 4: Permitting Agencies

Regulatory Agencies	
Federal	<ul style="list-style-type: none"> • Environmental Protection Agency (EPA) • Federal Emergency Management Agency (FEMA) • National Flood Insurance Program (NFIP) • National Marine Fisheries Service (NMFS) • National Park Service (NPS) • United States Army Corps of Engineers (USACE) • United States Coast Guard (USCG) • United States Fish and Wildlife Service (USFWS)
State	<ul style="list-style-type: none"> • RI Coastal Resources Management Council (RI CRMC) • RIDEM Freshwater Wetlands Program • RIDEM Office of Water Resources • Rhode Island Emergency Management Agency (RIEMA)

As noted above, RIDOT recommends the designer schedules a preapplication meeting with relevant agencies, specifically RIDEM and USACE, early in the design process to allow for comment on the project intent as early as possible. Preapplication meetings will help to balance the goals of a project with regulatory requirements, especially for new crossings. These

meetings can reduce back-and-forth between agencies, lead to a better stream crossing design, can result in faster construction time, and reduced project costs.

It should also be noted that some projects may need to meet standards that are stricter than the Design Standards presented in this Manual, if required by an applicable regulatory agency. These standards may include specific design criteria, conservation recommendations, and TOY restrictions. At a minimum, designers should review the TOY restrictions included below as well as the additional encroachment restrictions applied to work in tidal waters and non-tidal diadromous streams required by NMFS, USACE, and RIDEM. Encroachment activities are applied to projects that will require in-water soil erosion, sediment, and turbidity controls and may vary depending on the project location and time of year. TOY restrictions and proposed in-water controls should be discussed with the project’s regulating agencies during design.

Table 5: Time-of-Year Restrictions

Regulating Group	TOY Restriction
NOAA: NMFS/FHWA	Rhode Island: Winter Flounder: February 1 to June 30 Diadromous Fish: March 15 to June 30 and September 1 to November 30* Shellfish: May 1 to October 14 (NOAA’s National Marine Fisheries Service, 2018)
USACE	Rhode Island General Permits: Unconfined, in-stream work, not including installation and removal of cofferdams, is limited to the low-flow period, July 1 through October 31 unless RIDEM requires different resource-driven time of year restriction (U.S. Army Corps of Engineers New England District, 2018).
RIDEM	RIDOT recommends discussing this topic during the project’s preapplication meeting

**All diadromous areas: Use the fall TOY restriction in cases where an action will substantially block the waterway in the fall.*

Section 6: Final Design and Next Steps

This section of the Manual described the final steps required for completing and submitting a stream crossing design. The final crossing design should balance hydraulic and ecological objectives with crossing safety, life cycle cost, and other project or site constraints. All projects must be in accordance with State and Federal regulations. Once a design is complete, designers must submit the required plans and documents listed in *Section 4.2.12: Reporting Requirements*. After approval, the next steps include construction, inspection and long-term maintenance, outlined in this section below.

6.1 Construction Dewatering

During construction activities, streamflow should be managed to minimize impacts to the streambed, surrounding environment, and aquatic animals. If a structure has an open bottom, the stream should remain free flowing during installation when possible. If the project requires working “in the dry,” flow will need to be diverted or dammed, usually with a cofferdam. Cofferdams vary in design but act as a barrier to flow and are pumped out or otherwise dewatered after the dam is built, keeping the work area relatively dry until construction is complete. Diversion of flow may be preferred depending on the project and can be achieved with pipes, ditches, or other barriers. Pumped diversions may be appropriate for projects with low flows and a short duration but can cause high turbidity when pumped directly downstream and prevent upstream aquatic organism passage (Axness, 2013). Designers and planners should recommend a flow management technique in order to protect aquatic organisms and other resources based on the project. As

mentioned in Section 5, any applicable TOY and encroachment restrictions should be discussed with the project’s regulating agencies.

6.2 Operation and Maintenance (O&M)

The project engineers and designers must coordinate with RIDOT to develop an inspection and maintenance plan to implement over the crossing structure’s lifetime. Regular inspection and maintenance of road-stream crossings is essential to ensuring their continued proper function.

Key Items for Construction and Post-Construction Inspection:

- Channel cross section through the crossing mimics the natural channel shape including banks and low flow depths
- Wildlife bench material, if present, is traversable for anticipated terrestrial species and transitions to existing bank grades beyond the crossing
- Natural channel material is present through the crossing installed to minimum required depth
- Native, shade tolerant vegetation is present on slopes disturbed during construction and on banks within the crossing, if applicable
- Inlet and outlet elevations tie into upstream and downstream channel appropriately. Observe for evidence of scour, including formation of scour holes at crossing outlet or inlet, perched inlet/outlet, and washout of natural channel material
- Evidence of organism passage concerns (e.g. roadkill)

Standard O&M Practices:

- Inspect the crossing regularly, especially after heavy rains
- Clear any debris or blockages. Check for beaver damming activities, especially at culverts

Section 6: Final Design and Next Steps

- Repair minor stream channel defects through periodic grading or the addition of stone due to erosion from high flows
- Repair of wildlife benches including proper width, grading upstream and downstream of the structure, smaller material over riprap or large rocks, and native vegetation
- Check wildlife fencing (if present) after high flow events and repair any damages immediately
- Maintain all concrete work, rock riprap, grouted rock, flagstone or precast panels
- Immediately repair any vandalism, vehicular, or livestock damage to earthfills, side slopes, spillways, outlets or other appurtenances
- Maintain the roadway surface in a good condition, which includes periodic grading or repair of the surface. Prevent surface ponding by grading to remove depressions

The O&M plan should be developed prior to the final design of a crossing to minimize required maintenance and lifetime costs. The O&M plan for a crossing must be submitted within the Road-Stream Crossing Report (see the template in [Appendix C](#)). Designers should review the most recent RIDOT Bridge Inspection Manual for information on required inspections on public roadways.

Section 7: References

- AASHTO Journal. (2018, October 12). *State Farm Survey: Deer-Vehicle Collisions dropping, but costs rising*. <https://aashtojournal.org/2018/10/12/state-farm-survey-deer-vehicle-collisions-dropping-but-costs-rising/>
- American Association of State and Highway Transportation Officials (AASHTO). (2020). *LRFD Bridge Design Specifications, 9th Edition*. LRFDBDS-9. American Association of State Highway and Transportation Officials, Washington, D.C., 2020. <https://trid.trb.org/view/1704698>
- American Association of State and Highway Transportation Officials (AASHTO). (2020). *Standard Method of Test for Particle Size Analysis of Soils* (2020 Edition).
- ASTM. (2017). *Standard Test Method for Particle-Size Distribution (Gradation) of Fine-Grained Soils Using the Sedimentation (Hydrometer) Analysis (ASTM D7928-17)*. ASTM International, West Conshohocken, PA. <https://www.astm.org/Standards/D7928.htm>
- ASTM. (2017). *Standard Test Methods for Particle-Size Distribution (Gradation) of Soils Using Sieve Analysis (ASTM D6913 / D6913M-17)*. ASTM International, West Conshohocken, PA. <https://www.astm.org/Standards/D6913.htm>
- Axness, D. S. (2013). *Planning and Layout of Small-Stream Diversions*. United States Department of Agriculture Forest Service. <https://www.fs.fed.us/t-d/pubs/pdfpubs/pdf13251801/pdf13251801dpi100.pdf>
- Bates, K. (1999). *Fish Passage Design at Road Culverts*. Washington Department of Fish and Wildlife. <https://docs.streamnetlibrary.org/Protocols/103.pdf>
- Bates, K. (2003). *Design of Road Culverts for Fish Passage*. Washington Department of Fish and Wildlife. https://www.fs.fed.us/biology/nsaec/fishxing/fplibrary/Bates%20and%20others_2003_culvert_manual_final.pdf
- Bent, G. C., & Steeves, P. A. (2006). *A Revised Logistic Regression Equation and an Automated Procedure for Mapping the Probability of a Stream Flowing Perennially in Massachusetts* (Rep. No. Scientific Investigations Report 2006–5031). https://pubs.usgs.gov/sir/2006/5031/pdfs/SIR_2006-5031rev.pdf
- Bent, G. C., Steeves, P. A., & Waite, A. M. (2014). *Equations for Estimating Selected Streamflow Statistics in Rhode Island* (Rep. No. Scientific Investigations Report 2014–5010). <https://pubs.usgs.gov/sir/2014/5010/pdf/sir2014-5010.pdf>
- Clevenger, A. P. & Huijser, M. P. (2011). *Wildlife Crossing Structure Handbook Design and Evaluation in North America* (Rep No. FHWA-CFL/TD-11-003). Federal Highway Administration (FHWA). Washington, DC.

Section 7: References

- Clevenger, A. P., Chruszez, B., & Gunson, K. E. (2001). *Highway mitigation fencing reduces wildlife-vehicle collisions*. *Wildlife Society Bulletin* 2001, 29(2):646–653.
- Collins, M., R. Knutti, J. Arblaster, J.-L. Dufresne, T. Fichet, P. Friedlingstein, X. Gao, W.J. Gutowski, T. Johns, G. Krinner, M. Shongwe, C. Tebaldi, A.J. Weaver & M. Wehner. (2013). Long-term Climate Change: Projections, Commitments and Irreversibility. In: *Climate Change 2013: The Physical Science Basis. Contribution of Working Group I to the Fifth Assessment Report of the Intergovernmental Panel on Climate Change* [Stocker, T.F., D. Qin, G.-K. Plattner, M. Tignor, S.K. Allen, J. Boschung, A. Nauels, Y. Xia, V. Bex and P.M. Midgley (eds.)]. Cambridge University Press, Cambridge, United Kingdom and New York, NY, USA. https://www.ipcc.ch/site/assets/uploads/2018/02/WG1AR5_Chapter12_FINAL.pdf
- Connecticut Department of Environmental Protection. (2008, February 26). Stream Crossing Guidelines. Inland Fisheries Division Habitat Conservation and Enhancement Program. <https://portal.ct.gov/-/media/DOT/finalcrossingguidelinesFeb262008highrespdf.pdf>
- DeGaetano, A. T., & Castellano, C. M. (2017, March). *Downscaled Projections of Extreme Rainfall in New York State*. http://ny-idf-projections.nrc.cornell.edu/idf_tech_document.pdf
- Ettema, R., Nakato, T., & Muste, M. (2010, January). *Estimation of Scour Depth at Bridge Abutments* (NCHRP 24-20). http://onlinepubs.trb.org/onlinepubs/nchrp/docs/nchrp24-20_fr.pdf
- Federal Emergency Management Agency. (2019, May). *Stafford Act, as Amended, and Related Authorities: Homeland Security Act, as Amended (Emergency Management-related Provisions)*. <https://www.fema.gov/disasters/stafford-act>
- Federal Emergency Management Agency. (2021a, Feb 11). *New Culvert Works: No Flooding at East Street*. <https://www.fema.gov/case-study/new-culvert-works-no-flooding-east-street>
- Federal Emergency Management Agency. (2021b, Feb 11). *Wilcox Pond Culvert Upgrade Preventing Roadway Overtopping*. Retrieved from <https://www.fema.gov/case-study/wilcox-pond-culvert-upgrade-preventing-roadway-overtopping>
- Federal Highway Administration. (2006, July). *Hydraulic Design of Energy Dissipators for Culverts and Channels* (Hydraulic Engineering Circular No. 14, Third Edition, Publication No. FHWA-NHI-06-086). U.S. Department of Transportation. <https://www.fhwa.dot.gov/engineering/hydraulics/pubs/06086/hec14.pdf>

Section 7: References

- Federal Highway Administration. (2008, June). *Highways in the Coastal Environment* (Hydraulic Engineering Circular No. 25, Second Edition, Publication No. FHWA-NHI-07-096). U.S. Department of Transportation. <https://www.fhwa.dot.gov/engineering/hydraulics/pubs/07096/07096.pdf>
- Federal Highway Administration. (2009, September). *Bridge Scour and Stream Instability Countermeasures: Experience, Selection, and Design Guidance* (Hydraulic Engineering Circular No. 23, Third Edition, Publication No. FHWA-NHI-09-111). U.S. Department of Transportation. <https://www.fhwa.dot.gov/engineering/hydraulics/pubs/09111/09111.pdf>
- Federal Highway Administration. (2010, October). *Culvert Design for Aquatic Organism Passage* (Hydraulic Engineering Circular No. 26, First Edition, Publication No. FHWA-HIF-11-008). U.S. Department of Transportation. <https://www.fhwa.dot.gov/engineering/hydraulics/pubs/11008/hif11008.pdf>
- Federal Highway Administration. (2012, April). *Evaluating Scour at Bridges* (Hydraulic Engineering Circular No. 18, Fifth Edition, Publication No. FHWA-HIF-12-003). U.S. Department of Transportation. <https://www.fhwa.dot.gov/engineering/hydraulics/pubs/hif12003.pdf>
- Federal Highway Administration. (2012, April). *Stream Stability at Highway Structures* (Hydraulic Engineering Circular No. 20, Fourth Edition, Publication No. FHWA-HIF-12-004). U.S. Department of Transportation. <https://www.fhwa.dot.gov/engineering/hydraulics/pubs/hif12004.pdf>
- Forest Service Stream-Simulation Working Group (FSSSWG). (2008, August). *Stream Simulation: An Ecological Approach to Providing Passage for Aquatic Organisms at Road-Stream Crossings*. U.S. Department of Transportation, Federal Highway Administration Coordinated Federal Lands Highway Technology Implementation Program. Retrieved from <https://www.fs.fed.us/eng/pubs/pdf/StreamSimulation/hires/%20FullDoc.pdf>
- Fuss & O'Neill. (2017, May). *Wood-Pawcatuck Watershed Flood Resiliency Management Plan*. https://wpwa.org/documents/Flood%20Plan/Wood_Pawcatuck%20Flood%20Resiliency%20Plan%20Final%20August%202017.pdf
- Greenwood, J. (2017). *Municipal Climate Adaptation Guidance Series: Stream Smart Crossings*. Municipal Planning Assistance Program of the Maine Department of Agriculture Conservation and Forestry. https://www.maine.gov/dacf/municipalplanning/docs/CAGS_02A_StreamSmart%20Crossings.pdf

Section 7: References

- Huijser, M. et al. (2007). *Wildlife-Vehicle Collision and Crossing Mitigation Measures: a Toolbox for the Montana Department of Transportation*. Montana Department of Transportation. https://www.mdt.mt.gov/other/webdata/external/research/docs/research_proj/wildlife_crossing_mitigation/final_report.pdf
- Letcher B.H., Nislow K.H., Coombs J.A., O'Donnell M.J., & Dubreuil T.L. (2007). *Population Response to Habitat Fragmentation in a Stream-Dwelling Brook Trout Population*. PLoS ONE 2(11): e1139. <https://doi.org/10.1371/journal.pone.0001139>
- Levine, J. (2013, August). *An Economic Analysis of Improved Road-Stream Crossings* (Publication). <https://www.cwicny.org/files/Road-Stream%20Crossing%20Economic%20Analysis.pdf>
- Lyn, D. A., & Sangwan, N. (2016). *Ecologically Aware Design of Waterway-Encapsulating Structures* (Joint Transportation Research Program Publication No. FHWA/IN/JTRP-2016/21). West Lafayette, IN: Purdue University. <https://doi.org/10.5703/1288284316344>
- Massachusetts Department of Environmental Protection (MassDEP) Stormwater Advisory Committee. (2020, September 22). *Stormwater Advisory Committee Meeting #3 – Presentation*. <https://www.mass.gov/doc/stormwater-advisory-committee-meeting-3-presentation/download>
- Massachusetts Department of Fish and Game Division of Ecological Restoration (2015, March). *Economic & Community Benefits from Stream Barrier Removal Projects in Massachusetts*. <https://www.mass.gov/doc/phase-3-economic-community-benefits-from-stream-barrier-removal-projects-in-massachusetts/download>
- Massachusetts Department of Fish and Game Division of Ecological Restoration. (2018). *Massachusetts Stream Crossings Handbook*. <https://www.mass.gov/doc/massachusetts-stream-crossing-handbook/download>
- Minnesota Department of Natural Resources (DNR). (2014, October). *Best Practices for Meeting DNR General Public Waters Work Permit GP 2004-0001*. https://files.dnr.state.mn.us/waters/watermgmt_section/pwpermits/gp_2004_0001_full_document.pdf
- Narragansett Bay Estuary Program. (2017). *The State of Narragansett Bay and Its Watershed Technical Report*. https://drive.google.com/file/d/1dgeBNAZ7QofUJDAO7yKG9-uo_642dRvs/view

Section 7: References

- National Marine Fisheries Service & Federal Highway Administration. (2018, April). *Best Management Practices Manual for Transportation Activities in the greater Atlantic Region*. <https://www.fisheries.noaa.gov/new-england-mid-atlantic/consultations/section-7-take-reporting-programmatics-greater-atlantic>
- NOAA Office for Coastal Management. (1975). *Shoreline Mileage of the United States*. Washington, DC: National Oceanic and Atmospheric Administration. <https://coast.noaa.gov/data/docs/states/shorelines.pdf>
- NOAA's National Marine Fisheries Service. (2018, April). *FHWA Programmatic Essential Fish Habitat Consultation for Select Transportation Actions in the NMFS Greater Atlantic Region*. [https://media.fisheries.noaa.gov/dam-migration/fhwa_programmatic_efh_consultation_april_2018_\(2\).pdf](https://media.fisheries.noaa.gov/dam-migration/fhwa_programmatic_efh_consultation_april_2018_(2).pdf)
- Peterson, J., & McAllister, K. (2013, November 12). Fish Passage Design Aids Wildlife Crossing in Washington State—State of the Practice. <http://bnxo223rnq71rkvla2y3v3d7-wpengine.netdna-ssl.com/wp-content/uploads/2017/07/Washington-State-Fish-Crossings.pdf>
- Rhode Island Department of State. (2011, February). *Rules and Regulations Governing the Protection and Management of Freshwater Wetlands in the Vicinity of the Coast* (650-RICR-20-00-2). Rhode Island Administrative Code Title 650 - Coastal Resources Management Council. <https://rules.sos.ri.gov/regulations/part/650-20-00-2>
- Rhode Island Department of State. (2014, July). *Rules and Regulations Governing the Administration and Enforcement of the Fresh Water Wetlands Act* (250-RICR-150-15-1). Rhode Island Administrative Code Title 250 - Department of Environmental Management. <https://rules.sos.ri.gov/regulations/part/250-150-15-1>
- Rhode Island Department of State. (2018, November). *Stormwater Management, Design, and Installation Rules* (250-RICR-150-10-8), Rhode Island Administrative Code Title 250 - Department of Environmental Management. <https://rules.sos.ri.gov/regulations/part/250-150-10-8>
- Rhode Island Department of Transportation. (2007). *Rhode Island LRFD Bridge Design Manual*. Retrieved from <http://www.dot.ri.gov/documents/doingbusiness/RILRFDBridgeManual.pdf>
- Rhode Island Department of Transportation. (2013, October). *Bridge Inspection Manual*. http://www.dot.ri.gov/documents/doingbusiness/RIDOT_Bridge_Inspection_Manual.pdf

Section 7: References

- Rhode Island Department of Transportation. (2015, July 21). *Bridge Design Standard Details*. Retrieved from http://www.dot.ri.gov/documents/doingbusiness/RIDOT_Bridge_Standards.pdf
- Rhode Island Department of Transportation. (2018, March). *Standard Specifications for Road and Bridge Construction*. Retrieved from <http://www.dot.ri.gov/documents/doingbusiness/bluebook.pdf>
- Rhode Island Department of Transportation. (2019, August). *Road-Stream Crossing Assessment Handbook*. Retrieved from http://www.dot.ri.gov/documents/about/protecting/stormwater/RIDOT_Road-Stream_Crossing_Assessment_Handbook.pdf
- RI Resource Conservation & Development Area Council. (2013). *RI River & Stream Continuity Project*. <https://www.rircd.org/RI-River-Stream-Continuity.pdf>
- River and Stream Continuity Partnership. (2011, March 1). *Massachusetts River and Stream Crossing Standards*. https://www.nae.usace.army.mil/Portals/74/docs/regulatory/StreamRiverContinuity/MA_RiverStreamCrossingStandards.pdf
- The Louis Berger Group Inc. (2017, March). *NCHRO 25-25, Task 93: Long-term Construction and Maintenance Cost Comparison for Road Stream Crossings: Traditional Hydraulic Design vs. Aquatic Organism Passage Design*. AASHTO Standing Committee on Environment. [http://onlinepubs.trb.org/onlinepubs/nchrp/docs/NCHRP25-25\(93\)_FR.pdf](http://onlinepubs.trb.org/onlinepubs/nchrp/docs/NCHRP25-25(93)_FR.pdf)
- U.S. Army Corps of Engineers, New England District. (2015, January). *Stream Crossing Best Management Practices (BMPs)*. <https://www.nae.usace.army.mil/Portals/74/docs/regulatory/StateGeneralPermits/NEGP/BMPStreamCrossings21Jan2015.pdf>
- U.S. Army Corps of Engineers. (2016). Hydrologic Engineering Center's River Analysis System (HEC-RAS) (Version 5.0.7). <https://www.hec.usace.army.mil/software/hec-ras/>
- U.S. Fish and Wildlife Service. (2021). National Wild and Scenic Rivers System. <https://www.rivers.gov/wsr-act.php>
- United States Army Corps of Engineers New England District. (2018, August 15). *Errata sheet for the Rhode Island General Permits*. <https://www.nae.usace.army.mil/Portals/74/docs/regulatory/StateGeneralPermits/RI/RIGP-w-erratasheet.pdf>
- United States Department of Agriculture (USDA) and National Resources Conservation Service. (2018, April). *Operation and Maintenance Plan Stream Crossing, Code 578*. https://efotg.sc.egov.usda.gov/references/public/AL/578_OMPlan_Stream_Crossing.pdf

Section 7: References

United States Department of Agriculture (USDA). (2016, March 13). *White-tailed deer density estimates across the eastern United States, 2008*. <https://data.nal.usda.gov/dataset/white-tailed-deer-density-estimates-across-eastern-united-states-2008>

United States Department of Transportation (2016, December). *Table HM-10M - Highway Statistics 2015*. Federal Highway Administration. <https://www.fhwa.dot.gov/policyinformation/statistics/2015/hm10m.cfm>

United States Environmental Protection Agency. (2019, April 11). Section 404 of the Clean Water Act. <https://www.epa.gov/cwa-404/overview-clean-water-act-section-404>

United States Geological Survey (USGS). (2016). StreamStats v4.4.0. <https://streamstats.usgs.gov/ss/>

University of New Hampshire. (2009, May). *New Hampshire Stream Crossing Guidelines*. <https://www.des.nh.gov/organization/divisions/water/wetlands/documents/nh-stream-crossings.pdf>



Appendix A:

RIDOT Road-Stream Crossing Standards Review Checklist

Appendix A: RIDOT Road-Stream Crossing Standards Review Checklist

A.1 Existing Crossing

Design Criteria	Optimal Standards	Base Standards
Structure Type	<input type="checkbox"/> Bridge <input type="checkbox"/> 3-Sided Box Culvert <input type="checkbox"/> Open-Bottom Culvert <input type="checkbox"/> Arch Culvert <input type="checkbox"/> <i>Binned Overall Geomorphic Impact Score</i> ≥ 3 <input type="checkbox"/> Existing crossing does not meet Base or Optimal Standards. Structure type: _____	<input type="checkbox"/> Pipe Culvert with Embedment <input type="checkbox"/> Box Culvert with Embedment
Channel Velocities	<input type="checkbox"/> Velocity within the swimmable range of target species <input type="checkbox"/> Velocity comparable to reference reach at bankfull flow and range of base flows (if no target species present) <input type="checkbox"/> AOP study for target species <input type="checkbox"/> <i>Binned Aquatic Passability Score</i> ≥ 3	<input type="checkbox"/> Velocity comparable to natural channel at bankfull flow
Climate Change	<input type="checkbox"/> Hydraulic capacity designed for sea level rise and/or increased precipitation projections based upon Hydraulic Design Requirements	
Crossing Profile	<input type="checkbox"/> Crossing profile matches existing natural stream based upon reference reach <input type="checkbox"/> Profile designed using vertical adjustment potential (VAP) <input type="checkbox"/> <i>Binned Aquatic Passability Score</i> ≥ 3 <input type="checkbox"/> Existing crossing does not meet Base or Optimal Standards. Description of crossing profile: _____	<input type="checkbox"/> Crossing profile to match existing natural stream grade upstream and/or downstream of the crossing location
Embedment, Substrate and Channel Stability	<input type="checkbox"/> 1 foot (minimum) of natural substrate material above any required scour protection material <input type="checkbox"/> Channel cross section designed to mimic low flow depths of natural channel <input type="checkbox"/> Included grain size analysis and bed mobility/scour stability analysis <input type="checkbox"/> <i>Binned Overall Geomorphic Impact Score or Binned Aquatic Passability Score</i> ≥ 3 <input type="checkbox"/> Existing crossing does not meet Base or Optimal Standards. Existing embedment/substrate material and depth: _____	<input type="checkbox"/> Natural bottom substrate ≥ 2 feet for all structures ≥ 8 feet in span; $\geq 25\%$ of opening height for all spans < 8 feet <input type="checkbox"/> Channel cross section designed to mimic low flow depths of natural channel
Hydraulic Modeling	<input type="checkbox"/> HEC-RAS <input type="checkbox"/> Equivalent Software: _____ <input type="checkbox"/> <i>Binned Transportation Disruption Score</i> ≥ 3	<input type="checkbox"/> HY-8 <input type="checkbox"/> CulvertMaster <input type="checkbox"/> HydroCAD <input type="checkbox"/> Equivalent Software: _____
Openness Ratio	<input type="checkbox"/> Openness ratio ≥ 1.64 feet and height ≥ 6 feet <input type="checkbox"/> If conditions significantly inhibit wildlife, openness of ≥ 2.46 feet and height ≥ 8 feet <input type="checkbox"/> <i>Binned Aquatic Passability Score</i> ≥ 4 <input type="checkbox"/> Existing Crossing does not meet Base or Optimal Standards. Existing openness ratio = _____ feet	<input type="checkbox"/> Greater than or equal to 0.82 feet to the maximum extent practicable
Stream Crossing Span	<input type="checkbox"/> Hydraulic span greater than or equal 1.2 x BFW with banks on both sides designed for applicable wildlife passage. <input type="checkbox"/> <i>Binned Flood Impact Potential Score</i> ≥ 3 <input type="checkbox"/> Existing crossing does not meet Base or Optimal Standards. Existing crossing span = _____ feet	<input type="checkbox"/> Hydraulic span greater than or equal to 1.2 x BFW with banks on both sides
Structural Stability	<input type="checkbox"/> Designed in accordance with Rhode Island and AASHTO LRFD standards. Structural design includes appropriate loading including streamflow, span configuration and freeboard, wingwall layout and design, and footing design.	
Tidal/Coastal Guidance	<input type="checkbox"/> Velocity comparable to natural channel during the ebb and flow for high tide or maximum flow conditions and low tide/ low flow conditions based upon a detailed unsteady hydraulic modeling analysis. <input type="checkbox"/> <i>Binned Climate Change Vulnerability Score</i> ≥ 3	<input type="checkbox"/> Designed to accommodate the exchange of the full tidal prism using a simplified quantitative analysis (i.e. spreadsheet)

Appendix A: RIDOT Road-Stream Crossing Standards Review Checklist

A.2 Proposed Crossing

Design Criteria	Optimal Standards	Base Standards	Replacement Crossing: MEP Elaborate on reason for MEP within Road-Stream Crossing Report
Design Approach	<input type="checkbox"/> Stream Simulation	<input type="checkbox"/> AOP Design <input type="checkbox"/> Modified Hydraulic Design	<input type="checkbox"/> Maximum Extent Practicable
Structure Type	<input type="checkbox"/> Bridge <input type="checkbox"/> 3-Sided Box Culvert <input type="checkbox"/> Open-Bottom Culvert <input type="checkbox"/> Arch Culvert	<input type="checkbox"/> Pipe Culvert with Embedment <input type="checkbox"/> Box Culvert with Embedment	<input type="checkbox"/> Maximum Extent Practicable
Channel Velocities	<input type="checkbox"/> Velocity within the swimmable range of target species <input type="checkbox"/> Velocity comparable to reference reach at bankfull flow and range of base flows (if no target species present) <input type="checkbox"/> AOP study for target species	<input type="checkbox"/> Velocity comparable to natural channel at bankfull flow	<input type="checkbox"/> Maximum Extent Practicable
Climate Change	<input type="checkbox"/> Designed for sea level rise and/or increased precipitation projections based upon Hydraulic Design Requirements		
Crossing Profile	<input type="checkbox"/> Crossing profile matches existing natural stream based upon reference reach <input type="checkbox"/> Profile designed using vertical adjustment potential (VAP)	<input type="checkbox"/> Crossing profile to match existing natural stream grade upstream and/or downstream of the crossing location	<input type="checkbox"/> Maximum Extent Practicable
Embedment, Substrate and Channel Stability	<input type="checkbox"/> 1 foot (minimum) of natural substrate material above any required scour protection material <input type="checkbox"/> Channel cross section designed to mimic low flow depths of natural channel <input type="checkbox"/> Includes grain size analysis and bed mobility/scour stability analysis	<input type="checkbox"/> Natural bottom substrate ≥ 2 feet for all structures ≥ 8 feet in span; $\geq 25\%$ of opening height for all spans < 8 feet <input type="checkbox"/> Channel cross section designed to mimic low flow depths of natural channel	<input type="checkbox"/> Maximum Extent Practicable
Hydraulic Modeling	<input type="checkbox"/> HEC-RAS <input type="checkbox"/> Equivalent Software: _____	<input type="checkbox"/> HY-8 <input type="checkbox"/> CulvertMaster <input type="checkbox"/> HydroCAD <input type="checkbox"/> Equivalent Software: _____	<input type="checkbox"/> Maximum Extent Practicable
Openness Ratio	<input type="checkbox"/> Openness ratio ≥ 1.64 feet and height ≥ 6 feet <input type="checkbox"/> If conditions significantly inhibit wildlife, openness of ≥ 2.46 feet and height ≥ 8 feet	<input type="checkbox"/> Greater than or equal to 0.82 feet to the maximum extent practicable	
Stream Crossing Span	<input type="checkbox"/> Hydraulic span greater than or equal to $1.2 \times$ BFW with banks on both sides designed for applicable wildlife passage.	<input type="checkbox"/> Hydraulic span greater than or equal to $1.2 \times$ BFW with banks on both sides	<input type="checkbox"/> Maximum Extent Practicable
Structural Stability	<input type="checkbox"/> Design in accordance with Rhode Island and AASHTO LRFD standards. Structural design includes appropriate loading including streamflow, span configuration and freeboard, wingwall layout and design, and footing design. Hydraulic modeling and geotechnical analysis provide direction on foundation requirements and site-specific scour mitigation measures.		
Tidal/Coastal Guidance	<input type="checkbox"/> Velocity comparable to natural channel during the ebb and flow for high tide or maximum flow conditions and low tide/low flow conditions based upon a detailed unsteady hydraulic modeling analysis.	<input type="checkbox"/> Designed to accommodate the exchange of the full tidal prism using a simplified quantitative analysis (i.e. spreadsheet)	<input type="checkbox"/> Maximum Extent Practicable
Reporting Requirements	<input type="checkbox"/> Road-Stream Crossing Report (with H&H computations), Geotechnical Investigation, Hydraulic Performance Data Table, Conceptual Design Figure(s)		

Appendix A: Hydraulic Design Data Table

A.3 Hydraulic Design Data Table

Project Background	
Crossing Span (feet):	
Highway Functional Classification:	
Planned Construction Dates:	
Structure Service Life (years):	
Crossing Geometry	
Existing Condition Low Chord Elevation (feet):	
Proposed Condition Low Chord Elevation (feet):	
Hydraulic Design Requirements	
Design Storm Event:	
Existing Condition Design Storm Event Elevation (feet):	
Proposed Condition Design Storm Event Elevation (feet):	
Freeboard Requirement (feet):	
Freeboard Provided (feet):	
Design Scour Event:	
Check Scour Event:	
Climate Check Event:	
Pass Climate Check Event? Y/N/N.A.):	
Tidal and Sea Level Rise Influence	
Is the crossing currently impacted by tidal flow? (Y/N):	
Climate Change Projection Horizon Year:	
Will the crossing be impacted by the future MHHW based upon sea level rise for the Climate Change Projection Horizon Year? (Y/N/N.A.):	



Appendix B:

Conceptual Design Figures

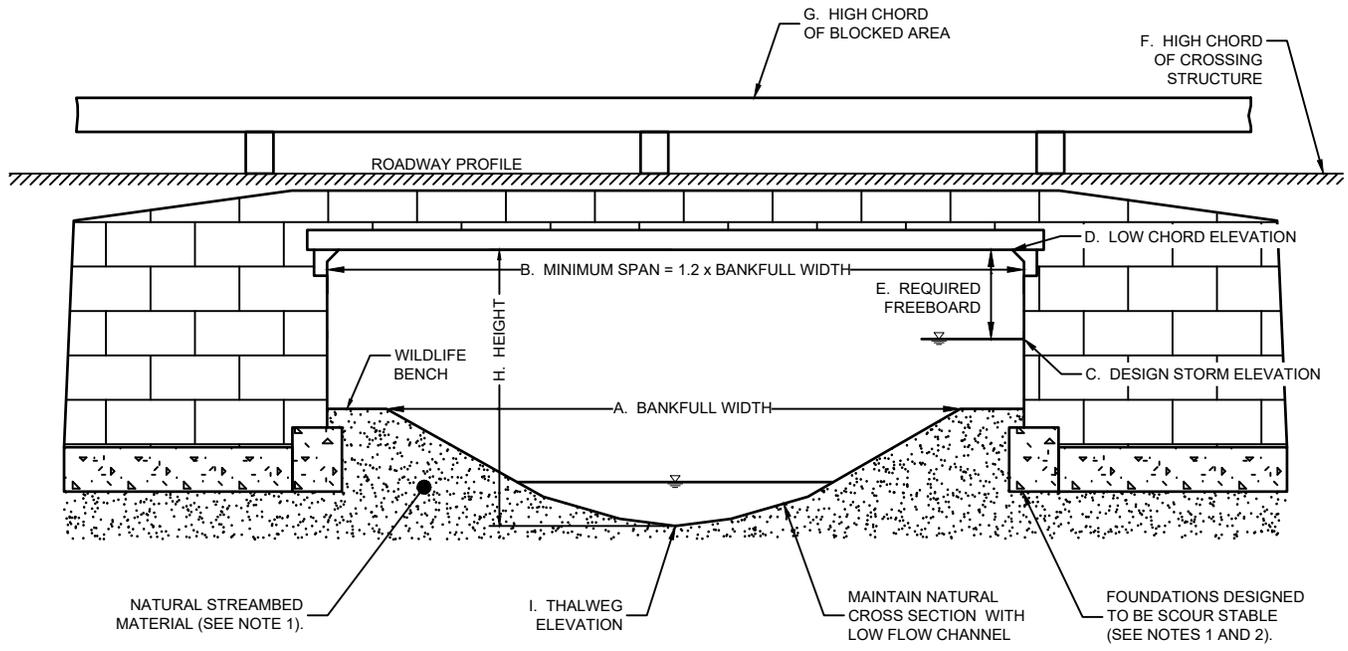

ELEVATION VIEW

NOTES:

1. CHANNEL CROSSING MATERIAL BASED UPON NATURAL CHANNEL GRAIN SIZE ANALYSIS, BED MOBILITY, AND SCOUR STABILITY ANALYSIS.
2. ALL FOUNDATION, WINGWALL, AND ABUTMENT DESIGN SHALL BE IN ACCORDANCE WITH THE RIDOT BRIDGE DESIGN MANUAL, AASHTO LRFD BRIDGE DESIGN SPECIFICATIONS AND STAMPED BY A PROFESSIONAL ENGINEER, LICENSED IN THE STATE OF RHODE ISLAND.
3. SCOUR ANALYSIS SHALL CONFIRM FOUNDATIONS ARE PROTECTED THROUGHOUT THE CHECK SCOUR STORM. PROVIDE PROTECTION AS NECESSARY.

HYDRAULIC FEATURES	
A. BANKFULL WIDTH (FT)	
B. PROVIDED SPAN (FT)	
C. DESIGN STORM ELEVATION (FT)	
D. LOW CHORD ELEVATION (FT)	
E. PROVIDED FREEBOARD (FT)	
F. HIGH CHORD ELEVATION (FT)	
G. HIGH CHORD OF BLOCK AREA (FT) (IF APPLICABLE)	
H. HEIGHT (FT)	
I. THALWEG ELEVATION (FT)	
J. BRIDGE LENGTH (FT) (PARALLEL TO FLOW)	

**RHODE ISLAND DEPARTMENT OF TRANSPORTATION
OPEN SPAN BRIDGE (ALL SPAN LENGTHS)**

REVISIONS		
NO.	BY	DATE

CHIEF ENGINEER
TRANSPORTATION

CHIEF DESIGN ENGINEER
TRANSPORTATION

ISSUE DATE



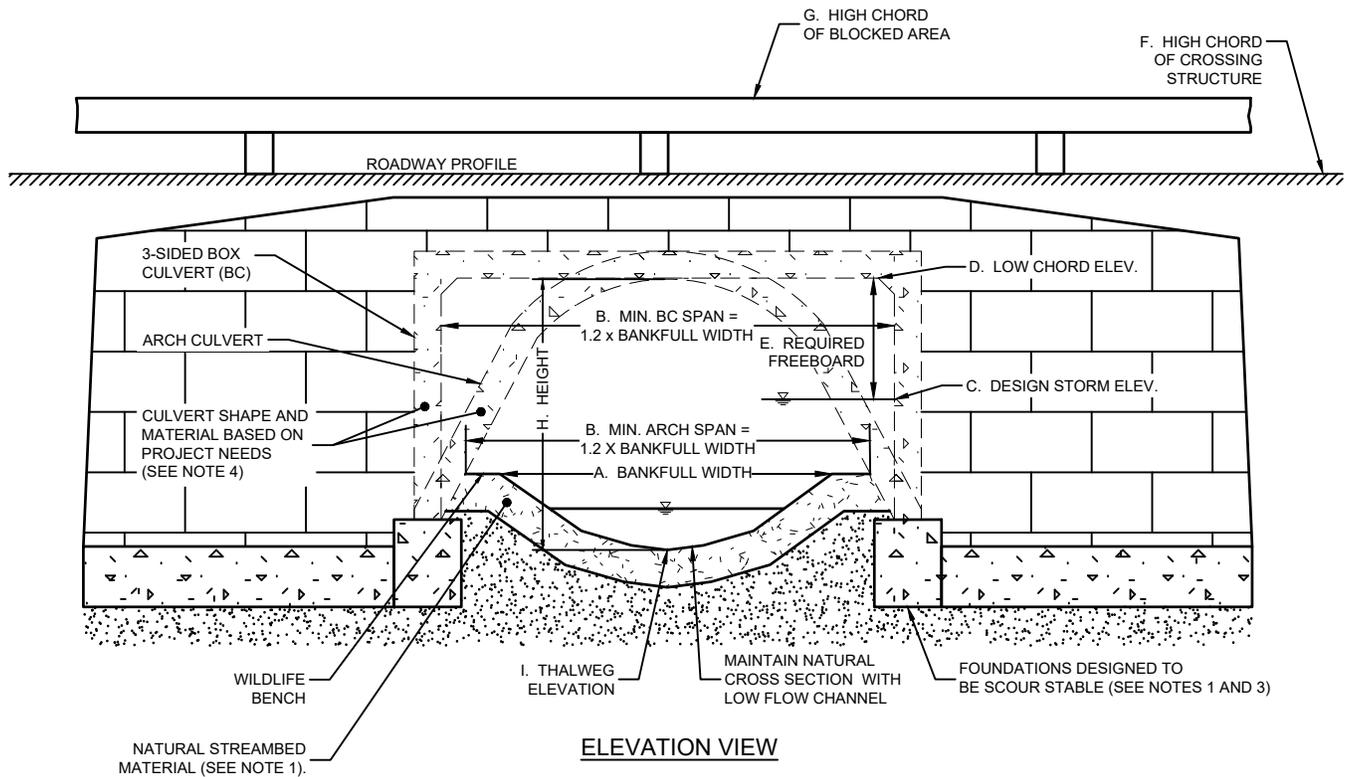

ELEVATION VIEW

NOTES:

1. CHANNEL CROSSING MATERIAL BASED UPON NATURAL CHANNEL GRAIN SIZE ANALYSIS, BED MOBILITY, AND SCOUR STABILITY ANALYSIS.
2. ALL FOUNDATION, WINGWALL, AND ABUTMENT DESIGN SHALL BE IN ACCORDANCE WITH THE RIDOT BRIDGE DESIGN MANUAL, AASHTO LRFD BRIDGE DESIGN SPECIFICATIONS AND STAMPED BY A PROFESSIONAL ENGINEER, LICENSED IN THE STATE OF RHODE ISLAND.
3. SCOUR ANALYSIS SHALL CONFIRM FOUNDATIONS ARE PROTECTED THROUGHOUT THE CHECK SCOUR STORM. PROVIDE PROTECTION AS NECESSARY.
4. VIEW ILLUSTRATES BOTH 3-SIDED BOX CULVERT OPTION AND ARCH CULVERT. DESIGNER TO CHOOSE BASED UPON PROJECT NEEDS.

HYDRAULIC FEATURES

HYDRAULIC FEATURES	
A. BANKFULL WIDTH (FT)	
B. PROVIDED SPAN (FT)	
C. DESIGN STORM ELEVATION (FT)	
D. LOW CHORD ELEVATION (FT)	
E. PROVIDED FREEBOARD (FT)	
F. HIGH CHORD ELEVATION (FT)	
G. HIGH CHORD OF BLOCK AREA (FT) (IF APPLICABLE)	
H. HEIGHT (FT)	
I. THALWEG ELEVATION (FT)	
J. BRIDGE LENGTH (FT) (PARALLEL TO FLOW)	

RHODE ISLAND DEPARTMENT OF TRANSPORTATION

3-SIDED BOX CULVERT & ARCH CULVERT

REVISIONS		
NO.	BY	DATE

CHIEF ENGINEER
TRANSPORTATION

CHIEF DESIGN ENGINEER
TRANSPORTATION

ISSUE DATE



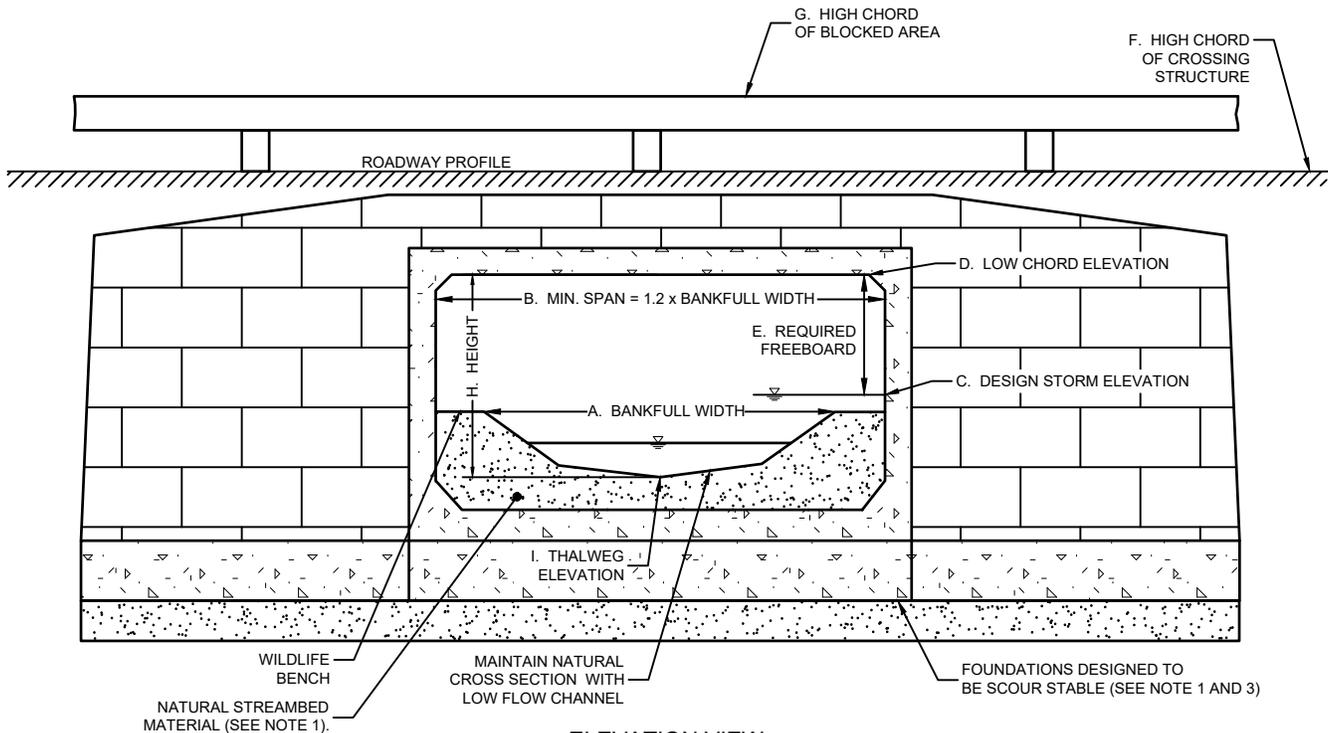

ELEVATION VIEW

NOTES:

1. CHANNEL CROSSING MATERIAL BASED UPON NATURAL CHANNEL GRAIN SIZE ANALYSIS, BED MOBILITY, AND SCOUR STABILITY ANALYSIS.
2. ALL FOUNDATION, WINGWALL, AND ABUTMENT DESIGN SHALL BE IN ACCORDANCE WITH THE RIDOT BRIDGE DESIGN MANUAL, AASHTO LRFD BRIDGE DESIGN SPECIFICATIONS AND STAMPED BY A PROFESSIONAL ENGINEER, LICENSED IN THE STATE OF RHODE ISLAND.
3. SCOUR ANALYSIS SHALL CONFIRM FOUNDATIONS ARE PROTECTED THROUGHOUT THE CHECK SCOUR STORM. PROVIDE PROTECTION AS NECESSARY.

HYDRAULIC FEATURES

HYDRAULIC FEATURES	
A. BANKFULL WIDTH (FT)	
B. PROVIDED SPAN (FT)	
C. DESIGN STORM ELEVATION (FT)	
D. LOW CHORD ELEVATION (FT)	
E. PROVIDED FREEBOARD (FT)	
F. HIGH CHORD ELEVATION (FT)	
G. HIGH CHORD OF BLOCK AREA (FT) (IF APPLICABLE)	
H. HEIGHT (FT)	
I. THALWEG ELEVATION (FT)	
J. BRIDGE LENGTH (FT) (PARALLEL TO FLOW)	

**RHODE ISLAND DEPARTMENT OF TRANSPORTATION
EMBEDDED BOX CULVERT**

REVISIONS		
NO.	BY	DATE

CHIEF ENGINEER
TRANSPORTATION

CHIEF DESIGN ENGINEER
TRANSPORTATION

ISSUE DATE



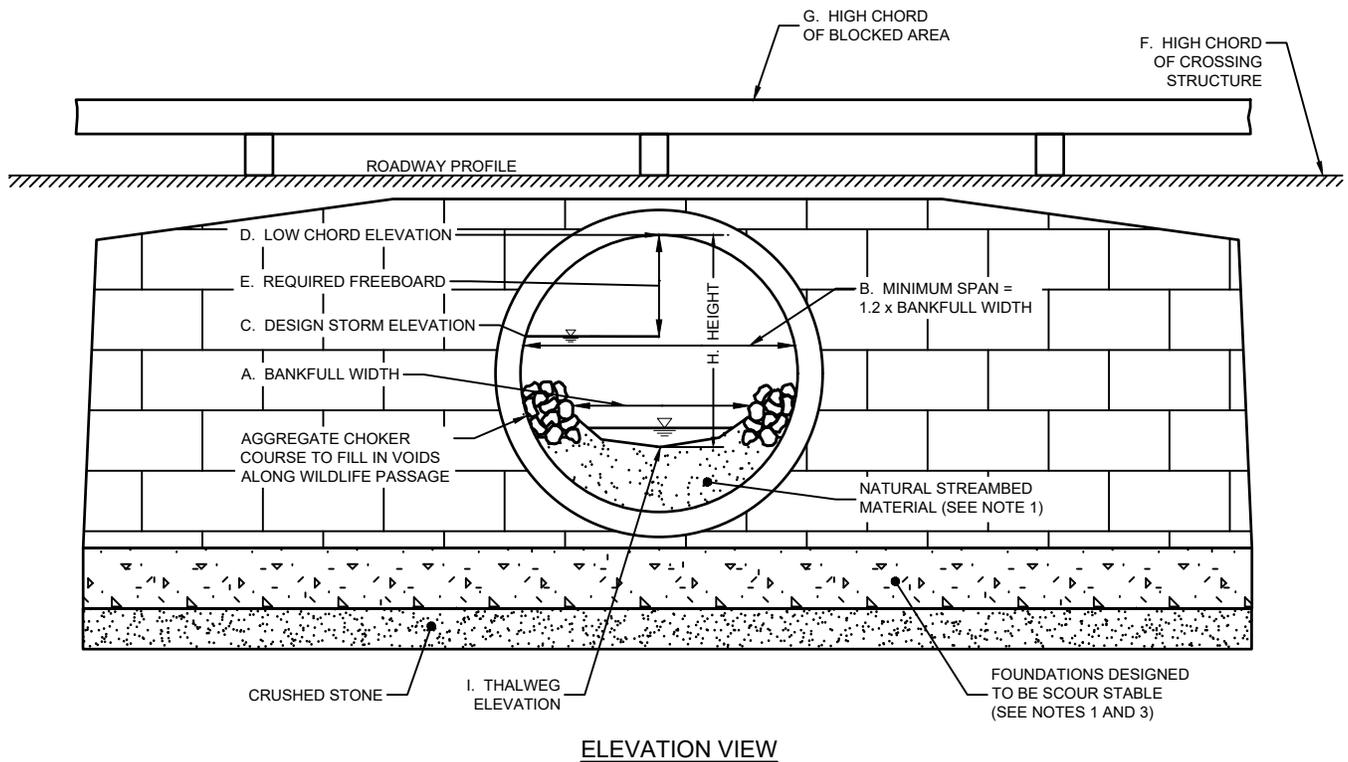

NOTES:

1. CHANNEL CROSSING MATERIAL BASED UPON NATURAL CHANNEL GRAIN SIZE ANALYSIS, BED MOBILITY, AND SCOUR STABILITY ANALYSIS.
2. ALL FOUNDATION, WINGWALL, AND ABUTMENT DESIGN SHALL BE IN ACCORDANCE WITH THE RIDOT BRIDGE DESIGN MANUAL, AASHTO LRFD BRIDGE DESIGN SPECIFICATIONS AND STAMPED BY A PROFESSIONAL ENGINEER, LICENSED IN THE STATE OF RHODE ISLAND.
3. SCOUR ANALYSIS SHALL CONFIRM FOUNDATIONS ARE PROTECTED THROUGHOUT THE CHECK SCOUR STORM. PROVIDE PROTECTION AS NECESSARY.

HYDRAULIC FEATURES	
A. BANKFULL WIDTH (FT)	
B. PROVIDED SPAN (FT)	
C. DESIGN STORM ELEVATION (FT)	
D. LOW CHORD ELEVATION (FT)	
E. PROVIDED FREEBOARD (FT)	
F. HIGH CHORD ELEVATION (FT)	
G. HIGH CHORD OF BLOCK AREA (FT) (IF APPLICABLE)	
H. HEIGHT (FT)	
I. THALWEG ELEVATION (FT)	
J. BRIDGE LENGTH (FT) (PARALLEL TO FLOW)	

**RHODE ISLAND DEPARTMENT OF TRANSPORTATION
EMBEDDED PIPE CULVERT**

REVISIONS		
NO.	BY	DATE

CHIEF ENGINEER
TRANSPORTATION

CHIEF DESIGN ENGINEER
TRANSPORTATION

ISSUE DATE





Appendix C:

Road-Stream Crossing Report Template

RIDOT Road-Stream Crossing Report Template

Instructions: All black text within this template should remain as titles/headers in the final report, all blue text is guidance and should be updated or deleted by the consultant.

Cover Page

Project Name and Location

PTSID Number

Bridge ID (If applicable)

RIDOT Contact Information

Consultant Contact Information

Stamp of Rhode Island P.E.

Table of Contents

1. Executive Summary	1
2. Project Description	2
2.1 Existing Conditions	2
2.1 Proposed Conditions	3
3. Engineering Methods	4
3.1 Hydrologic Analysis	4
3.2 Hydraulic Analysis	4
3.3 Bridge Scour Analysis	4
4. Road-Stream Crossing Design Standards	5
4.1 Road-Stream Crossing Design Standards	5
4.1.1 Design Approach	5
4.1.2 Structure Type	5
4.1.3 Channel Velocities	5
4.1.4 Climate Change	6
4.1.5 Crossing Profile	6
4.1.6 Embedment, Substrate, and Channel Stability	6
4.1.7 Hydraulic Modeling	6
4.1.8 Openness Ratio	7
4.1.9 Stream Crossing Span	7
4.1.10 Structural Stability	7
4.1.11 Tidal/Coastal Modeling	7
4.1.12 Reporting Requirements	7
4.1.13 Construction Best Management Practices	8
4.1.14 Operations and Maintenance (O&M)	8
5. Conclusions	9

5.1	Conclusions	9
5.2	Recommendations.....	9
6.	References	12
7.	Figures.....	13
8.	Appendices	15
8.1	Data Collection	
8.2	NFIP Documentation	
8.3	Photo log	
8.4	Hydrologic Backup	
8.5	Hydraulic Backup	
8.6	Scour and Countermeasure Calculations	

List of Tables

Table 1: Hydraulic Design Requirements

List of Figures

Figure 1: RIDOT Road-Stream Crossing Design Manual - Conceptual Design Figure

1. Executive Summary

Summarize of project scope, existing conditions, existing crossing structure (if applicable), proposed design, hydraulic modeling methodology and results, and key recommendations and/or conclusions.

2. Project Description

2.1 Existing Conditions

Describe of the existing structure location, type, size, owner, structural condition, stream condition, and any other relevant information. Include site photographs in the appendix.

Subsections (with these titles or similar) should include:

- Waterway at the Crossing
 - Watershed features, land cover, impervious area, bankfull width, channel stability, any hydraulic features (dams, pump stations, etc.)
- Roadway Functional Classification
 - In accordance with the Section 4 of the RIDOT Road-Stream Crossing Design Manual (2021) list the hydraulic design requirements based on the roadway functional classification at the crossing:

Table 1: Hydraulic Design Requirements

RIDOT Highway Functional Classification:	
Design Storm (AEP):	
Design Scour (AEP):	
Check Scour (AEP):	
Climate Check (AEP) or Climate Change Projection Horizon:	

- Land Use at Crossing
 - Land use and land cover in the vicinity of the crossing
- Special Site Considerations (if applicable)
 - National Flood Insurance Program (NFIP) flood zone(s) and/or compliance “No-Rise” analysis
 - Threatened or endangered federal and state listed species and habitat
 - Essential fish habitat
 - Wild and Scenic River corridor
 - Wetland areas and special aquatic sites
 - Other resource considerations

2.2 Proposed Conditions

Describe of the proposed action (e.g., bridge replacement, retrofit, etc.) and any alternative designs. The RIDOT Road-Stream Crossing Manual (2021) provides details on selecting a crossing location (Section 2.2) and recommended design approaches (Section 3).

3 Engineering Methods

3.1 Hydrologic Analysis

Provide the methodology (model type) and results of the hydrologic analysis. This section may include discharge rates from the NFIP FIS, hydrologic analysis inputs, a peak flood frequency analysis, and/or use of regression equations to determine peak flows for the applicable project AEPs. Documentation of hydrologic calculations should be provided in the appendix.

3.2 Hydraulic Analysis

Provide the methodology (model type) and results of the hydraulic analysis. The following subsections should include a description of the hydraulic model (HEC-RAS or equivalent) with key results, including estimates of water surface elevations for the applicable AEPs, and comparison to existing conditions. Documentation of hydraulic calculations and model results should be provided in the appendix. Section 4.2.7 of the RIDOT Road-Stream Crossing Manual (2021) provides details on the requirements for hydraulic modeling.

Subsections should include:

- Existing Conditions Model
- Proposed Conditions Model
- NFIP No-Rise Analysis (if applicable)

3.3 Bridge Scour Analysis

Provide the methodology (e.g. HEC-18), assumptions, and results (depths and/or elevations) of the scour analysis for the existing and proposed conditions. Include any scour countermeasure sizing calculations in this section and provide documentation of calculations in the appendix.

4 Road-Stream Crossing Design Standards

4.1 Road-Stream Crossing Design Standards

Describe how the proposed design meets the standards from the RIDOT Road-Stream Crossing Design Manual (see Section 4 of the Manual) in each subsection below. If the design does not meet the Optimal Standards for a design criterion, provide back-up describing RIDOT's approval for this change and information demonstrating that the proposed crossing design is an improvement over the existing crossing if the project is a replacement project. Designers should provide the completed RIDOT Road-Stream Crossing Design Manual Standards Review Checklist(s) and Hydraulic Performance Data Table in Section 5 of this report. Designers should also include the completed applicable Conceptual Design Figure from the RIDOT Road-Stream Crossing Design Manual (Appendix B of the Manual) with any additional figures submitted with this report.

4.1.1 Design Approach

Provide the design approach of the proposed crossing, described in Section 3 of the RIDOT Road-Stream Crossing Design Manual. If the approach is not Stream Simulation (the Optimal Standard), demonstrate how the proposed design approach results in a structure that is an improvement over the existing crossing (Section 4.2.1 of the RIDOT Road-Stream Crossing Design Manual).

4.1.2 Structure Type

Describe how the proposed crossing structure meets the Optimal Standard for structure type. If the structure does not meet the Optimal Standard, demonstrate how the proposed crossing structure is an improvement over the existing crossing structure or meets the standard to the maximum extent practicable. See Section 4.2.2 of the RIDOT Road-Stream Crossing Design Manual for more details on structure type requirements.

4.1.3 Channel Velocities

Provide the results of an AOP study for the stream at the crossing location (if a target aquatic organism is present), which at a minimum compares the swimming velocities of any known species with the base flow velocities of the proposed design. An AOP study is required for projects within defined cold-water fisheries, diadromous fish habitat, or otherwise required by the RIDOT Environmental Division. If an AOP study was not conducted, provide documentation that the flow velocity within the proposed crossing is comparable to the natural channel (or reference reach) at bankfull flow. See Section 4.2.3 of the RIDOT Road-Stream Crossing Design Manual for more details on channel velocity requirements.

4.1.4 Climate Change

Describe how increased precipitation and, if applicable, sea level rise projections were accounted for in the proposed design based upon the applicable Climate Change Projection Horizon or the Climate Check Storm (see Table 3: Hydraulic Design Requirements). See Sections 2.3 and 4.2.4 in the RIDOT Road-Stream Crossing Design Manual for information on climate change and sea level rise design requirements.

4.1.5 Crossing Profile

Describe the location and characteristics (bankfull width, slope, stability, etc.) of the reference reach used for the proposed design. If the structure does not meet the Optimal Standard by using a reference reach, demonstrate that the proposed crossing profile matches the existing natural stream grade upstream and/or downstream of the crossing, or matches to the maximum extent practicable. See Section 4.2.5 of the RIDOT Road-Stream Crossing Design Manual for more details on crossing profile requirements.

4.1.6 Embedment, Substrate, and Channel Stability

Describe the embedment (type and depth) at the proposed crossing and the results of a grain size analysis and bed mobility/scour stability analysis used to determine the substrate material. If the design does not meet the Optimal Standard, demonstrate how the embedment/substrate of proposed design is an improvement over the existing crossing or meets the standard to the maximum extent practicable. See Section 4.2.6 of the RIDOT Road-Stream Crossing Design Manual for more details on embedment and substrate requirements.

This section should also discuss the following topics:

- Proposed depth of embedment compared to the proposed structure dimensions (i.e. 25% of opening height, etc.)
- Inclusion of five-point cross section (either discussion or figure) to allow for low flow channel depths
- The removal of existing structure and/or substructure

4.1.7 Hydraulic Modeling

Describe the modeling program/software used to model the existing and proposed crossings and if the model meets the Optimal Standard. If the model does not meet the Optimal Standard, describe the chosen modeling program and how it effectively models the existing and proposed conditions. All other details of the hydraulic model, including results, should be included in the Hydraulic Analyses section (Section 3.2) of this report. See Section 4.2.7 of the RIDOT Road-Stream Crossing Design Manual for more details on hydraulic modeling requirements.

4.1.8 Openness Ratio

Provide the openness ratio of the proposed crossing and whether it meets the Optimal Standard. If the structure does not meet the Optimal Standard for openness, demonstrate how the proposed design is an improvement over the existing crossing or meets the standard to the maximum extent practicable. See Section 4.2.8 of the RIDOT Road-Stream Crossing Design Manual for more details on openness ratio requirements.

4.1.9 Stream Crossing Span

Provide the span of the proposed crossing structure (perpendicular to the channel) compared to the bankfull width of the existing stream or river, information on crossing span alignment, and the design of any banks or benches for wildlife passage. If the structure does not meet the Optimal Standard for span, demonstrate how the proposed design is an improvement over the existing crossing or meets the standard to the maximum extent practicable. See Section 4.2.9 of the RIDOT Road-Stream Crossing Design Manual for more details on structure span requirements.

4.1.10 Structural Stability

Describe how the proposed design accounts for appropriate loading, span configuration, wingwall layout and design, and footing design. Reference to a separate structural analysis is also acceptable. Information on the scour analysis and sizing of site-specific scour mitigation measures should be included in Section 3.3 Bridge Scour Analysis of this report. See Section 4.2.10 of the RIDOT Road-Stream Crossing Design Manual for more details on structural stability requirements.

4.1.11 Tidal/Coastal Modeling

For crossings located in areas of tidal influence, provide model results (unsteady HEC-RAS model or equivalent to achieve the Optimal Standard) that demonstrate the velocity at the crossing is comparable to natural channel during the ebb and flow at high tide or maximum flow conditions and low tide/low flow conditions. If the crossing does not meet the Optimal Standard, provide results of a simplified quantitative volume analysis (e.g., spreadsheet) that demonstrate the crossing is designed to accommodate the exchange of the full tidal prism. Include any results of analyzing flood risk and regulatory compliance of replacing an existing crossing in a tidally influence area. See Section 4.2.11 of the RIDOT Road-Stream Crossing Design Manual for more details on tidal modeling requirements.

4.1.12 Reporting Requirements

Describe how the project meets all reporting requirements.

Required submittals to RIDOT include:

- Geotechnical Investigation

- Hydrologic and Hydraulic Computations (include in Section 3 and Appendices of this report)
- Road-Stream Crossing Standards Review Checklist(s) (provided in Section 5 of this template)
- Hydraulic Performance Data Table (provided in Section 5 of this template)
- The applicable Conceptual Design Figure (include in Section 7 of this report)
- Road-Stream Crossing Report (this template)

All submittal documents listed above with exception of the **Geotechnical Investigation** are included within this report template.

4.2 Construction Best Management Practices

Discussion of construction activities and dewatering or stream flow management (if applicable) recommendations for the project. Describe how these activities will minimize impacts to surrounding sensitive resources to the maximum extent practicable. See Section 6.1 of the RIDOT Road-Stream Crossing Manual for more information on dewatering practices.

4.3 Operations and Maintenance (O&M)

Describe any operations and maintenance procedures necessary for maintaining roadway safety and aquatic organism passage over the lifetime of the structure. Include a list of key items for post-construction maintenance including clearing of debris, maintaining channel low flow cross sections, wildlife benches (if applicable), native vegetation, and natural channel grades. See Section 6.2 of the RIDOT Road-Stream Crossing Manual for more information on maintenance practices and the RIDOT Bridge Inspection Manual (2013) for information on inspections on public roadways.

5 Conclusions

5.1 Conclusions

Summarize the key conclusions of the hydrologic and hydraulic analyses including scour, freeboard, "no-rise" certification (if applicable), and how the proposed design meets the RIDOT Road-Stream Crossing Manual design standards. Complete the RIDOT Road-Stream Crossing Standards Review Checklist(s) and Hydraulic Performance Data Table included in this section. For existing crossings, designers should fill out both RIDOT Road-Stream Crossing Standards Review Checklists. For new crossings, designers only need to fill out the checklist for the proposed crossing.

5.2 Recommendations

Include any additional recommendations such as scour countermeasures, alternative designs, or construction best management practices.

Existing Crossing

Design Criteria	Optimal Standards	Base Standards
Structure Type	<input type="checkbox"/> Bridge <input type="checkbox"/> 3-Sided Box Culvert <input type="checkbox"/> Open-Bottom Culvert <input type="checkbox"/> Arch Culvert <input type="checkbox"/> <i>Binned Overall Geomorphic Impact Score ≥ 3</i> <input type="checkbox"/> Existing crossing does not meet Base or Optimal Standards. Structure type: _____	<input type="checkbox"/> Pipe Culvert with Embedment <input type="checkbox"/> Box Culvert with Embedment
Channel Velocities	<input type="checkbox"/> Velocity within the swimmable range of target species <input type="checkbox"/> Velocity comparable to reference reach at bankfull flow and range of base flows (if no target species present) <input type="checkbox"/> AOP study for target species <input type="checkbox"/> <i>Binned Aquatic Passability Score ≥ 3</i>	<input type="checkbox"/> Velocity comparable to natural channel at bankfull flow
Climate Change	<input type="checkbox"/> Hydraulic capacity designed for sea level rise and/or increased precipitation projections based upon Hydraulic Design Requirements	
Crossing Profile	<input type="checkbox"/> Crossing profile matches existing natural stream based upon reference reach <input type="checkbox"/> Profile designed using vertical adjustment potential (VAP) <input type="checkbox"/> <i>Binned Aquatic Passability Score ≥ 3</i> <input type="checkbox"/> Existing crossing does not meet Base or Optimal Standards. Description of crossing profile: _____	<input type="checkbox"/> Crossing profile to match existing natural stream grade upstream and/or downstream of the crossing location
Embedment, Substrate and Channel Stability	<input type="checkbox"/> 1 foot (minimum) of natural substrate material above any required scour protection material <input type="checkbox"/> Channel cross section designed to mimic low flow depths of natural channel <input type="checkbox"/> Included grain size analysis and bed mobility/scour stability analysis <input type="checkbox"/> <i>Binned Overall Geomorphic Impact Score or Binned Aquatic Passability Score ≥ 3</i> <input type="checkbox"/> Existing crossing does not meet Base or Optimal Standards. Existing embedment/substrate material and depth: _____	<input type="checkbox"/> Natural bottom substrate ≥ 2 feet for all structures ≥ 8 feet in span; $\geq 25\%$ of opening height for all spans < 8 feet <input type="checkbox"/> Channel cross section designed to mimic low flow depths of natural channel
Hydraulic Modeling	<input type="checkbox"/> HEC-RAS <input type="checkbox"/> Equivalent Software: _____ <input type="checkbox"/> <i>Binned Transportation Disruption Score ≥ 3</i>	<input type="checkbox"/> HY-8 <input type="checkbox"/> CulvertMaster <input type="checkbox"/> HydroCAD <input type="checkbox"/> Equivalent Software: _____
Openness Ratio	<input type="checkbox"/> Openness ratio ≥ 1.64 feet and height ≥ 6 feet <input type="checkbox"/> If conditions significantly inhibit wildlife, openness of ≥ 2.46 feet and height ≥ 8 feet <input type="checkbox"/> <i>Binned Aquatic Passability Score ≥ 4</i> <input type="checkbox"/> Existing Crossing does not meet Base or Optimal Standards. Existing openness ratio = _____ feet	<input type="checkbox"/> Greater than or equal to 0.82 feet to the maximum extent practicable
Stream Crossing Span	<input type="checkbox"/> Hydraulic span greater than or equal 1.2 x BFW with banks on both sides designed for applicable wildlife passage. <input type="checkbox"/> <i>Binned Flood Impact Potential Score ≥ 3</i> <input type="checkbox"/> Existing crossing does not meet Base or Optimal Standards. Existing crossing span = _____ feet	<input type="checkbox"/> Hydraulic span greater than or equal to 1.2 x BFW with banks on both sides
Structural Stability	<input type="checkbox"/> Designed in accordance with Rhode Island and AASHTO LRFD standards. Structural design includes appropriate loading including streamflow, span configuration and freeboard, wingwall layout and design, and footing design.	
Tidal/Coastal Guidance	<input type="checkbox"/> Velocity comparable to natural channel during the ebb and flow for high tide or maximum flow conditions and low tide/ low flow conditions based upon a detailed unsteady hydraulic modeling analysis. <input type="checkbox"/> <i>Binned Climate Change Vulnerability Score ≥ 3</i>	<input type="checkbox"/> Designed to accommodate the exchange of the full tidal prism using a simplified quantitative analysis (i.e. spreadsheet)

Proposed Crossing

Design Criteria	Optimal Standards	Base Standards	Replacement Crossing: MEP Elaborate on reason for MEP within Road-Stream Crossing Report
Design Approach	<input type="checkbox"/> Stream Simulation	<input type="checkbox"/> AOP Design <input type="checkbox"/> Modified Hydraulic Design	<input type="checkbox"/> Maximum Extent Practicable
Structure Type	<input type="checkbox"/> Bridge <input type="checkbox"/> 3-Sided Box Culvert <input type="checkbox"/> Open-Bottom Culvert <input type="checkbox"/> Arch Culvert	<input type="checkbox"/> Pipe Culvert with Embedment <input type="checkbox"/> Box Culvert with Embedment	<input type="checkbox"/> Maximum Extent Practicable
Channel Velocities	<input type="checkbox"/> Velocity within the swimmable range of target species <input type="checkbox"/> Velocity comparable to reference reach at bankfull flow and range of base flows (if no target species present) <input type="checkbox"/> AOP study for target species	<input type="checkbox"/> Velocity comparable to natural channel at bankfull flow	<input type="checkbox"/> Maximum Extent Practicable
Climate Change	<input type="checkbox"/> Designed for sea level rise and/or increased precipitation projections based upon Hydraulic Design Requirements		
Crossing Profile	<input type="checkbox"/> Crossing profile matches existing natural stream based upon reference reach <input type="checkbox"/> Profile designed using vertical adjustment potential (VAP)	<input type="checkbox"/> Crossing profile to match existing natural stream grade upstream and/or downstream of the crossing location	<input type="checkbox"/> Maximum Extent Practicable
Embedment, Substrate and Channel Stability	<input type="checkbox"/> 1 foot (minimum) of natural substrate material above any required scour protection material <input type="checkbox"/> Channel cross section designed to mimic low flow depths of natural channel <input type="checkbox"/> Includes grain size analysis and bed mobility/scour stability analysis	<input type="checkbox"/> Natural bottom substrate ≥ 2 feet for all structures ≥ 8 feet in span; $\geq 25\%$ of opening height for all spans < 8 feet <input type="checkbox"/> Channel cross section designed to mimic low flow depths of natural channel	<input type="checkbox"/> Maximum Extent Practicable
Hydraulic Modeling	<input type="checkbox"/> HEC-RAS <input type="checkbox"/> Equivalent Software: _____	<input type="checkbox"/> HY-8 <input type="checkbox"/> CulvertMaster <input type="checkbox"/> HydroCAD <input type="checkbox"/> Equivalent Software: _____	<input type="checkbox"/> Maximum Extent Practicable
Openness Ratio	<input type="checkbox"/> Openness ratio ≥ 1.64 feet and height ≥ 6 feet <input type="checkbox"/> If conditions significantly inhibit wildlife, openness of ≥ 2.46 feet and height ≥ 8 feet	<input type="checkbox"/> Greater than or equal to 0.82 feet to the maximum extent practicable	
Stream Crossing Span	<input type="checkbox"/> Hydraulic span greater than or equal to $1.2 \times \text{BFW}$ with banks on both sides designed for applicable wildlife passage.	<input type="checkbox"/> Hydraulic span greater than or equal to $1.2 \times \text{BFW}$ with banks on both sides	<input type="checkbox"/> Maximum Extent Practicable
Structural Stability	<input type="checkbox"/> Design in accordance with Rhode Island and AASHTO LRFD standards. Structural design includes appropriate loading including streamflow, span configuration and freeboard, wingwall layout and design, and footing design. Hydraulic modeling and geotechnical analysis provide direction on foundation requirements and site-specific scour mitigation measures.		
Tidal/Coastal Guidance	<input type="checkbox"/> Velocity comparable to natural channel during the ebb and flow for high tide or maximum flow conditions and low tide/low flow conditions based upon a detailed unsteady hydraulic modeling analysis.	<input type="checkbox"/> Designed to accommodate the exchange of the full tidal prism using a simplified quantitative analysis (i.e. spreadsheet)	<input type="checkbox"/> Maximum Extent Practicable
Reporting Requirements	<input type="checkbox"/> Road-Stream Crossing Report (with H&H computations), Geotechnical Investigation, Hydraulic Performance Data Table, Conceptual Design Figure(s)		

Hydraulic Design Data Table

Project Background	
Crossing Span (feet):	
Highway Functional Classification:	
Planned Construction Dates:	
Structure Service Life (years):	
Crossing Geometry	
Existing Condition Low Chord Elevation (feet):	
Proposed Condition Low Chord Elevation (feet):	
Hydraulic Design Requirements	
Design Storm Event:	
Existing Condition Design Storm Event Elevation (feet):	
Proposed Condition Design Storm Event Elevation (feet):	
Freeboard Requirement (feet):	
Freeboard Provided (feet):	
Design Scour Event:	
Check Scour Event:	
Climate Check Event:	
Pass Climate Check Event? Y/N/N.A.):	
Tidal and Sea Level Rise Influence	
Is the crossing currently impacted by tidal flow? (Y/N):	
Climate Change Projection Horizon Year:	
Will the crossing be impacted by the future MHHW based upon sea level rise for the Climate Change Projection Horizon Year? (Y/N/N.A.):	

6 References

List all sources for data collection used for analysis and any other information referenced in this report.

7 Figures

7.1 RIDOT Road-Stream Crossing Design Manual - Conceptual Design Figure

Include any additional figures of the site area, watershed, existing crossing, and/or proposed design.

8 Appendices

- 8.1 Data Collection
- 8.2 NFIP Documentation
- 8.3 Photo log
- 8.4 Hydrologic Backup
- 8.5 Hydraulic Backup
- 8.6 Scour and Countermeasure Calculations



Appendix D:

Glossary of Terms

Appendix D: Glossary of Terms

Annual Exceedance Probability (AEP): The probability of a flood event occurring in any year. For example, the 1% AEP flood has a 1% chance of occurring or being exceeded in any given year. The probability of flood occurrence is also commonly defined by a specific return period. Table 1 shows the relationship between AEP and return interval for common flood events.

Flood Event AEP and Return Period

Annual Exceedance Probability (AEP) (%)	Return Period (years)
50	2
10	10
4	25
2	50
1	100
0.2	500

Aquatic Organism Passage (AOP): The natural, unrestricted movement of aquatic species through a crossing structure. AOP design is the modification or removal of barriers that restrict or impede movement of aquatic organisms in order to facilitate that movement.

Arch: An arch or pipe-arch is a type of culvert that is arched to achieve a lower, wider crossing shape. Arches are usually open-bottom structures while pipe-arches are fully enclosed.

Bankfull Flow: The point at which water completely fills the stream channel and where additional water would overflow into the floodplain. See Assessment Handbook: Section 3.5.2 for additional detail on determining bankfull flow.

Bankfull Width (BFW): A measurement of the width of the active stream channel at bankfull flow. See Assessment Handbook: Section 3.5.2 for additional detail on determining bankfull flow.

Bridge: A crossing that has a deck supported by abutments. Abutments may be earthen or constructed of wood, stone, masonry, concrete, or other materials. A bridge may have multiple cells, divided by one or more piers. The RIDOT Bridge Inspection Manual defines a bridge as a structure over a depression or an obstruction with a length of more than 20 feet (2013, as amended). Designers should review the latest RIDOT Bridge Inspection Manual for updated definitions. See Assessment Handbook: Section 1.2.3 for additional details.

Check Scour: The 24-hour storm event that the crossing's scour countermeasures must be designed to, and that must be scour stable but not necessarily available for use afterwards.

Climate Check: The 24-hour storm event used to determine the required hydraulic capacity of a crossings (without the inclusion of freeboard) to account for climate change.

Culvert: A culvert is any crossing structure that is not a bridge and is usually buried under some amount of fill. Culverts can be fully enclosed (contain a bottom) or have an open bottom. For the purpose of this Manual, an arch is considered an open-bottom culvert.

Design Scour: The 24-hour storm event that the crossing's foundations, abutments, or piers must be designed to, and that the crossing must be scour stable for and available for use afterwards.

Design Storm: The 24-hour storm event at a given AEP used to determine the required hydraulic capacity of a crossing, with the inclusion of freeboard.

Designer: The party contacted by RIDOT to complete the assessment and design of a particular stream crossing.

Ecological: Relating to or concerned with the relation of living organisms to one another and to their physical surroundings.

Appendix D: Glossary of Terms

Freeboard: Freeboard is the distance between the upstream water surface elevation and the low chord of the crossing structure. The location of the upstream water surface elevation will vary based upon the hydraulic model used in the design. Below is a description of this location for common hydraulic modeling software:

HEC-RAS (Hydrologic Engineering Center River Analysis System): Two cross sections upstream of the crossing (also known as Cross Section 4) where the flow has not yet been impacted by contraction of the crossing.

HydroCAD Stormwater Modeling Software: The location of the upstream water surface elevation will vary based on the method of modeling. The designer should use engineering judgement to best interpolate the elevation approximately one to two bridge widths upstream of the crossing or where flow has not yet been impacted by contraction of the crossing.

HY-8 Culvert Hydraulic Analysis Program: The location of the upstream water surface elevation will vary based on the method of modeling. Due to the limitations of this model, the designer should utilize engineering judgement and will likely have to use the water surface elevation at the upstream face of the crossing.

Geomorphic: Relating to the shape of the landscape and landforms. Geomorphic impacts to road-stream crossings occur when the crossing alters the surrounding stream channel and landscape.

Headcutting: An erosional feature that causes an abrupt vertical drop in the channel bed elevation. Headcuts usually begin at a knickpoint (a sharp change in channel slope) and can migrate upstream within a channel.

Hydraulic: The study of fluid mechanics and the flow of water through a stream, river, channel, and/or stream crossing.

Hydraulic Capacity: The amount of water that a crossing can safely convey, usually corresponding to a specific design storm or flow rate.

Hydrologic Engineering Center River Analysis System (HEC-RAS): A software program from the U.S. Army Corps of Engineers Hydrologic Engineering Center that allows users to perform one-dimensional steady flow, one and two-dimensional unsteady flow calculations, sediment transport/mobile bed computations, and water temperature/water quality modeling.

Hydrology: The study of the occurrence, distribution, movement and properties of the water through the environment within each phase of the water cycle.

Life Cycle Cost: The total cost of a crossing structure over its life cycle including initial capital costs, maintenance costs, operating costs, and the structure's residual value at the end of its life.

Maximum Extent Practicable (MEP): For the purpose of this Manual, designing to the MEP means aiming to achieve the Base or Optimal Standards whenever possible while taking into consideration cost, available technology, and project site constraints.

Mean Higher High Water (MHHW): A measurement representing the vertical extent of tidal influence in a specific area, obtained by taking the average of the higher high water height of each tidal day observed over the National Tidal Datum Epoch.

North American Vertical Datum of 1988 (NAVD 88): The vertical datum for orthometric heights established for vertical control surveying in the United States in 1991. NAVD 88 is the official vertical datum of the United States, having superseded the older National Geodetic Vertical Datum of 1929 (NGVD 29).

Appendix D: Glossary of Terms

Planning Horizon: A length of time into the future that is accounted for in a particular plan. In this Manual planning horizon is used to describe a length of time into the future for the purpose of planning for climate change.

Reference Reach: A river or stream segment that represents the natural, stable channel and is used to develop crossing design criteria including bankfull width, slope, and other characteristics used in Stream Simulation design.

Scour: The erosion or degradation of a riverbed (vertical scour) or riverbanks (lateral scour) by flowing water.

Stream Crossing: A location where infrastructure (roadway, railroad, pipeline, etc.) crosses a stream channel. This includes crossings at intermittent streams that are dry during certain times of the year.

Stream Simulation: A method for designing and building road-stream crossings intended to permit free and unrestricted movements of any aquatic species. Stream Simulation is outlined in detail in the U.S. Forest Service document *Stream Simulation: An Ecological Approach to Providing Passage for Aquatic Organisms at Road-Stream Crossings* (2008).

StreamStats: A web application from the United States Geological Survey that provides access to spatial analytical tools that are useful for water-resources planning and management, and for engineering and design purposes. The map-based user interface can be used to delineate drainage areas, get basin characteristics and estimates of flow statistics, among other features.

Thalweg: The deepest part of a stream channel. See [Figure 4-3: Five Point Cross Section](#) for illustration.

Vertical Adjustment Potential (VAP): The range of potential vertical streambed adjustment (due to erosion or deposition) over the service life of a crossing structure. The upper and lower VAP lines represent respectively the highest and lowest likely elevations of any point on the streambed surface (FSSWG, 2008).



Appendix E:

Synthesis of Existing Guidance Memorandum



To: Alisa Richardson, RIDOT
Nicole Leporacci, RIDOT

Date: December 4, 2020

Memorandum

Project #: 73052.03

From: Anniqve Fleurat, VHB
Ariana Wetzel, VHB

Re: RIDOT Road-Stream Crossing Design Manual: Synthesis of Existing
Guidance Memorandum

VHB is preparing the Road-Stream Crossing Design Manual ("the Manual") for the Rhode Island Department of Transportation ("RIDOT"). VHB has completed a literature review of existing road-stream crossing guidance throughout the United States, with a focus in the New England region, in preparation for determining the appropriate guidance for Rhode Island. This memorandum summarizes the literature review findings of the existing guidance, presents the design criteria and approaches, and presents the road-stream crossing proposed standards that VHB has determined to be most applicable and appropriate for Rhode Island.

Literature Review of Existing Guidance

VHB reviewed over 30 existing stream crossing design manuals, guidance handbooks, regulatory documents, and online resources, which can be found in the attached list of references, to understand best practices and begin to provide recommendations for RIDOT's proposed Manual. VHB examined available literature associated with enhanced culvert conveyance, aquatic organism passage ("AOP"), stream continuity, and small bridge design. VHB also reviewed the *RIDOT Road-Stream Crossing Assessment Handbook* ("Assessment Handbook"), which provides guidance on evaluating and prioritizing existing crossings in Rhode Island. This memorandum assumes the reader has a general knowledge of the Assessment Handbook.

In order to summarize and organize the results of the literature review, VHB developed Figure 1, which is a quantitative bar graph of the design criteria covered within the various sources. The design criteria are the topics that VHB's engineering experience has determined to be the most impactful on the detailed design of a crossing structure, the project decision making process, and which guide the industry standards. The bar graph provides a visual representation of the popularity of each design topic within the existing literature. VHB examined each document for the various criteria related to stream crossing design, listed on the horizontal axis of the graph. For each design topic, the blue bar represents the number of documents that include design criteria or complete guidance for the associated topic and the green bar represents the number of documents that included partial design criteria or mention the associated topic but with no specific guidance.

Figure 1 - Literature Review Summary

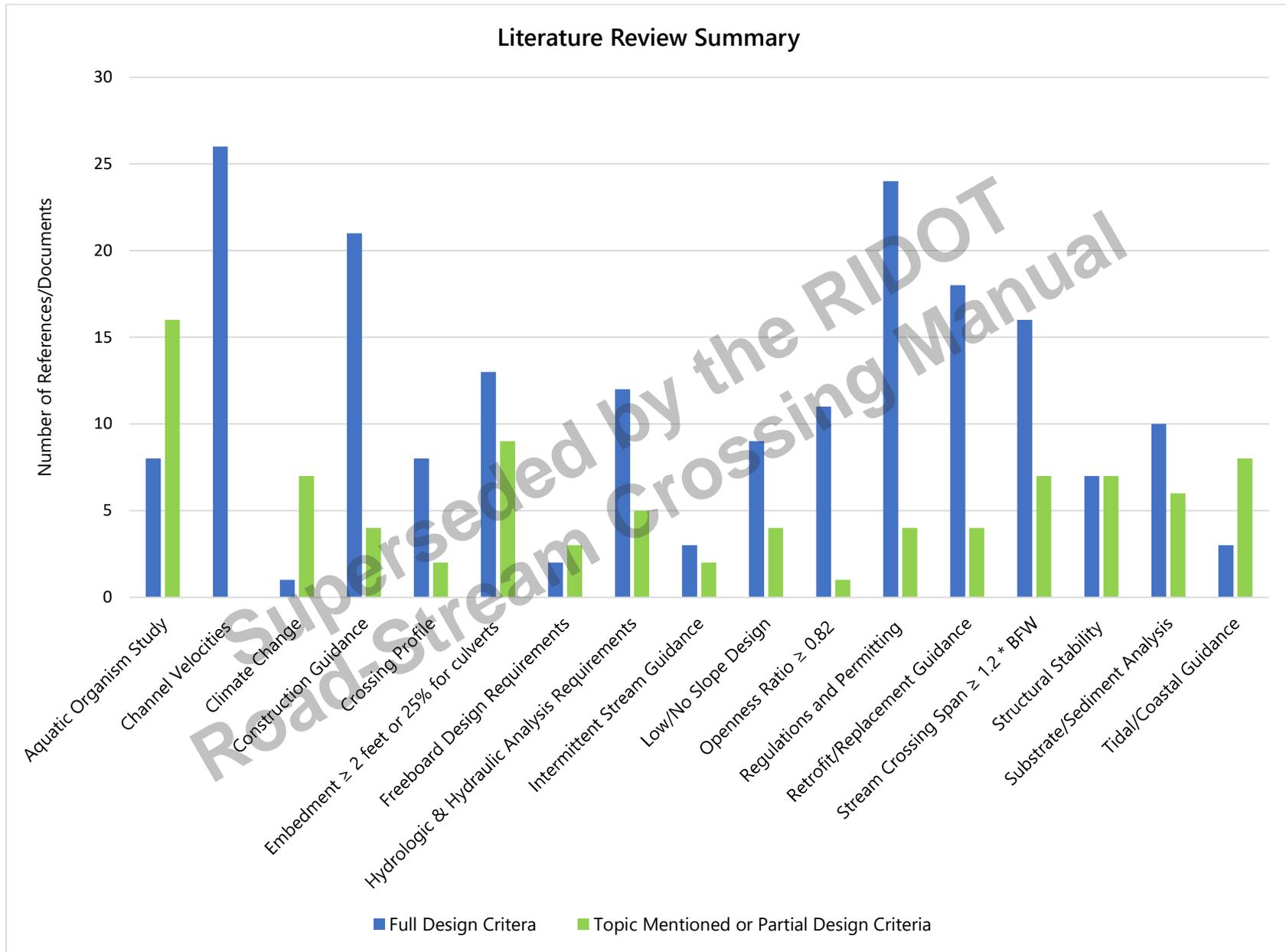



Memorandum

From the graph we can infer that the topics with the highest counts, specifically the counts shown in the blue bars, are the current industry standards in road-stream crossing design and guidance. The topics more broadly covered, shown in the green bars, are considered important in stream crossing design and will likely be included in the proposed Manual but may not require specific design standards or guidance.

Design Criteria

Descriptions of the design criteria described in Figure 1 are provided in the list below, in alphabetic order:

Aquatic Organism Study – Aquatic organism studies are recommended when designing for passage of a target species. The swimming speeds and leaping abilities of different age groups within the target fish species should be considered when designing a stream crossing.

Channel Velocities – Flow velocities in the crossing structure should approximate those in the natural river/stream channel. Depending on goals the project, an aquatic organism passage study may be necessary to understand factors affecting fish mobility and migration. The RIDOT Assessment Handbook categorizes crossings with significantly faster or slower flow velocities compared to the rest of the stream as a potential barrier to passage. Channel velocities also impact the channel stability and structural stability as a factor for potential scour. This is discussed further under the Structural Stability design criteria.

Climate Change – The RIDOT Assessment Handbook currently recommends designing for the year 2100 with a projected 20% increase in precipitation and peak flow, which is consistent with other state-wide planning efforts. Based on the literature review, many guidance documents do not discuss climate change or how to account for projected changes in precipitation and flow conditions. The proposed Manual will likely require crossings to be designed to accommodate future climate conditions, including sea level rise and increased precipitation projections. As climate change and sea level rise projections can be updated as frequently as every year, the proposed Manual will likely only suggest sources of projections and not provide specific values for projections of sea level rise or increased precipitation.

Construction Guidance – Construction best management practices (“BMPs”), timing, and design may vary by location. In general, the most favorable time for constructing or replacing road-stream crossings is during periods of low flow, from July 1 through October 31. Based on the literature review, a stream channel can usually remain free flowing under a bridge crossing during part or all of the construction process, avoiding the need for dewatering or diversion. Dewatering is more likely required during construction of smaller crossings or culverts and should be designed to minimize the extent and duration of dewatering activities and cofferdam structures. Substrate material can be installed and compacted with machinery or washed into the structure depending on the size of the crossing structure. If the project is in an area with species that are listed as endangered, threatened, or of special concern, construction activities may be limited to minimize impacts

101 Walnut Street

PO Box 9151

Watertown, MA 02472-4026

P 617.924.1770



Memorandum

to those species as required under the federal Endangered Species Act or by the RI Department of Environmental Management.

Crossing Profile – The road-stream crossing profile should match the elevations and longitudinal profile of the natural stream channel, with channel design based on a suitable reference reach. A reference reach is a nearby unaltered portion of the stream that the designer has observed to be naturally stable based on the morphology (FSSWG, 2008). By matching the vertical profile of a crossing to the natural stream, the structure has a greater likelihood of achieving similar flow velocities of the natural channel and accommodating bed material movement and future bed profiles. The horizontal profile of the crossing should also match the existing stream and banks to ensure slope stability and allow for AOP. For culvert replacement projects, further evaluation is needed to provide a design that will not disrupt stream stability and potentially cause unstable vertical profile movement.

Embedment – Embedment of crossing structures is based on the “Stream Simulation” design approach, outlined below and described in a detailed manual published by the Forest Service Stream-Simulation Working Group (FSSWG, 2008). Stream simulation is achieved by using open-bottom structures or by placing fill within closed structures to mimic a natural streambed. Sufficient embedment allows for natural movement of bedload and formation of a stable bed inside the stream crossing without exposing or undermining the crossing structure. Embedment also ensures adequate ecosystem connectivity and wildlife accessibility to both sides of the stream crossing.

Freeboard Design Requirements – Freeboard is the distance between the upstream water elevation and a reference point on the crossing, often the low chord or overtopping elevation. Freeboard requirements can vary based upon roadway classification and design storm requirements.

Hydrologic & Hydraulic Analysis Requirements – A hydrologic and hydraulic analysis should be conducted for all road-stream crossing projects. Hydrologic analysis includes the use of rainfall-runoff models, regional flood-flow regression equations, or statistical analysis of peak-flow records at representative stream gages to determine associated flood flows at the crossing. The hydraulic analysis should model the predicted flows through existing and proposed crossing to design the proposed structure to convey floods of varying magnitudes without failure.

Intermittent Stream Guidance – Many intermittent streams (streams with flow for only part of the year) serve as seasonal habitat for fish and wildlife and should be designed for AOP. Intermittent streams should be designed to the same minimum standards as road-stream crossings at perennial streams (streams with flow throughout year).

Low/No Slope Design – Low slope or no slope design is recommended in some guidance documents for projects with a low gradient channel and short stream crossing. Low/no-slope designs are expected to pass

101 Walnut Street

PO Box 9151

Watertown, MA 02472-4026

P 617.924.1770



Memorandum

fish when sized appropriately and installed on a gradient of $< 1\%$ at sites with a natural stream gradient of $< 3\%$ (Bates, 2009; CalTrans, 2007; MassDOT Highway Division, 2010). Low/no-slope designs can result in stream crossings that do not mimic the slope of the natural stream channel and can cause channel instability. Therefore, low/no-slope designs are not recommended for the proposed Manual.

Openness Ratio – Openness is the cross-sectional area of a structure opening (not including the embedded area) divided by its crossing length. The United States Army Corps of Engineers (USACE) New England District guidance states that stream crossings should achieve an openness ratio of greater than or equal to (\geq) 0.82 feet (0.25 meters) in order to provide dry passage for semi-aquatic and small terrestrial wildlife. Connecticut, Maine, Massachusetts and New Hampshire all require or recommend the same openness ratio (\geq 0.82 feet (0.25 meters)). Structures that meet this openness standard are much more likely to pass flood flows and woody debris that would otherwise obstruct water passage. If conditions significantly inhibit wildlife or if terrestrial animal passage is a major concern, a crossing should achieve an openness of ratio \geq 2.46 feet (0.75 meters) and a height \geq 8 feet (2.4 meters) (River and Stream Continuity Partnership, 2001). Openness standards for larger terrestrial passage are primarily based on a study by Reed et al. in 1979, which concluded that 0.6 meters (2.0 feet) is the minimum openness needed for mule and whitetail deer to use a structure.

Openness ratios should be considered whenever appropriate and practicable given present species, biological health of the water course, upstream or downstream constraints, cost, feasibility, goals of resource agencies, and other site or project specific considerations. The USACE Stream Crossing Best Management Practices do not require an openness ratio minimum for tidal crossings. The RIDOT Assessment Handbook, which preceded this memorandum does not specify a required openness for a crossing but evaluates openness in the *Aquatic Passability Score* and considers crossings with greater openness to have a lower impact on wildlife passage. The Assessment Handbook also requests the user to observe signs of wildlife crossing including live wildlife and roadkill reporting.

Regulations and Permitting – Based on the literature review, most guidance documents provide a list of federal and state regulatory agencies and associated permitting requirements for road-stream crossing design. A list of applicable regulatory agencies will be included in the proposed Manual and is also included in the Key Methods for Proposed Manual section of this memo.

Retrofit/Replacement Guidance – Some crossing design issues can be addressed with retrofits by making modifications to improve aquatic organism passage, stream flow, or structural stability instead of a full replacement. However, crossing replacement is typically the most long-term cost-effective choice and offers the best opportunity for restoring natural stream continuity at problem crossings. Both retrofit and replacement guidance will be included in the proposed Manual.



Memorandum

Stream Crossing Span – Stream crossings should span the natural stream channel and the industry standard is to size a crossing at a minimum of 1.2 times the natural bankfull width (BFW) to avoid or minimize disruption to the streambed. This design criterion was first introduced in Washington State in 2003 and based on a study that observed structures 1.3 times the channel BFW to replicate natural stream processes and create similar passage conditions (Barnard, 2003). Similarly, wide-spanning culverts and open bottom structures with widths greater than the natural BFW were found to provide a buffer against lateral and vertical stream adjustments (Bates, 2003). Many states and agencies have since found that using a span of 1.2 times BFW, compared to Barnard's result of 1.3, is sufficient to replicate natural stream processes and permit organism passage (Connecticut Dept. of Environmental Protection, 2008; Greenwood, 2007; Massachusetts Division of Ecological Restoration, 2018; National Marine Fisheries Service, 2018).

The standard of sizing open-bottom structures or culverts of 1.2 times the natural BFW is required by Massachusetts, Maine, Connecticut, and the USACE New England District. Additionally, the Assessment Handbook considers crossings that span the full channel and banks to have a lower impact potential rating and risk of failure.

Structural Stability – The structural stability of a crossing, including load analysis, foundation design, scouring of the stream bed, frost mitigation, and risk of material failure should be incorporated into the crossing design. Depending on the crossing structure and location, geotechnical analysis of the crossing may also be necessary. Design criteria included in the proposed Manual will not replace federal and state structural design standards.

Substrate/Sediment Analysis - Substrate within the stream crossing should match the characteristics of the natural stream channel and the banks (mobility, slope, stability, confinement, grain and rock size). The method of replicating the natural stream substrate within a crossing structure is the basis of the stream simulation approach discussed further in the design approaches below (FSSWG, 2008).

Tidal/Coastal Guidance – To avoid disrupting AOP, tidally influenced crossings should replicate flow conditions during all normal tide cycles. Crossings should be sized to accommodate the ebb and flow during high tide or maximum flow conditions and low tide/low flow conditions. The RIDOT Assessment Handbook provides guidance on determining tidal influence based on a project location relative to the Rhode Island Mean Higher High Water ("MHHW") line. The proposed Manual will likely require detailed hydraulic analyses at tidally influenced crossings.

VHB has condensed the design criteria above to the key design criteria. The key design criteria are the criteria that VHB has found to be the most applicable to the detailed design of stream crossings and for the priorities of the State of Rhode Island. VHB specifically examined key design criteria for each New England states as part of the literary



Memorandum

review to inform the development of the proposed standards for the RIDOT Manual. The key design criteria requirements for each New England state are shown in Table 1 below.

Superseded by the RIDOT
Road-Stream Crossing Manual



Memorandum

Table 1: Key Design Criteria Requirements in New England

Design Criteria	Connecticut	Maine	Massachusetts	New Hampshire	Vermont
Climate Change	No guidance.	No guidance.	Recommend designing to future storm characteristics. No specific guidance.	Greater span lengths recommended. No specific guidance.	No guidance.
Crossing Profile	Profile and slope should match existing natural stream.	Profile and slope should match existing natural stream.	Profile and slope should match existing natural stream.	Profile and slope should match existing natural stream.	Slope should match existing natural stream or shallower.
Embedment	≥ 1 ft for all crossings and ≥ 20% for pipes > 10 ft diameter.	≥ 2 ft or 25% (whichever is greater) for all crossings.	≥ 2 ft for all culverts and ≥ 25% for round pipe culverts.	≥ 2 ft for box and smooth wall culverts, ≥ 1 ft for corrugated pipe arches, ≥ 1 ft and ≥ 25 % for corrugated round pipe culverts.	≥ 20% for all crossings.
Channel Velocities	Design to maximum velocity for target fish species.	Design to maximum velocity for target fish species.	Flow rates should be comparable to natural channel.	Flow rates should be comparable to natural channel.	Design to maximum velocity for target fish species.
Openness Ratio	≥ 0.82 ft (0.25 m)	≥ 2.0 ft (0.60 m) recommended.	≥ 0.82 ft (0.25 m)	≥ 0.82 ft (0.25 m) recommended.	No guidance.
Stream Crossing Span	≥ 1.2 x BFW	≥ 1.2 x BFW	≥ 1.2 x BFW	≥ 1.2 x BFW recommended.	≥ BFW
Structural Stability	No guidance.	No guidance.	Notes additional analysis is needed to ensure structural stability.	No guidance.	Notes additional analysis is needed to ensure structural stability.
Substrate/Sediment Analysis	Natural channel substrate.	Natural channel substrate.	Natural channel substrate.	Natural channel substrate.	Natural channel substrate.

101 Walnut Street

PO Box 9151

Watertown, MA 02472-4026

P 617.924.1770



Memorandum

Tidal/Coastal Guidance	No guidance.	No guidance.	The standards were developed for "non-tidal rivers and streams and may not be appropriate for coastal waterways."	No guidance.	No guidance.
------------------------	--------------	--------------	---	--------------	--------------

The key design criteria include both Climate Change and Tidal/Coastal Guidance which are not currently included by other New England states, as shown above. The climate change predictions from the Intergovernmental Panel on Climate Change ("IPCC") have had multiple iterations of publications and have increased the severity of climate change with each new publication. For this reason, VHB and RIDOT agree that climate change should be accounted for as part of the proposed stream-crossing manual. Additionally, as part of its 1,045 square mile land mass, the State of Rhode Island has 384 miles of coastline resulting in a significant number of tidally influenced the stream crossings. Both VHB and RIDOT also agree that Tidal/Coastal Guidance is important for stream-crossing design in the state of Rhode Island.

Design Approaches

Many documents within the literature review discussed and explained different approaches that can be taken when completing stream-crossing design, with each approach accounting for the design criteria above to varying degrees. There are four historically accepted stream-crossing design approaches within the discipline, as described below:

1. Stream Simulation Design (Geomorphic Design) "is an approach to designing crossing structures (usually culverts), that creates a structure that is as similar as possible to the natural channel." (FSSWG, 2008). The premise of stream simulation design is that if a stream crossing mimics the natural channel (dimension, slope, and substrate), water velocities and depths also will be similar. Therefore, the simulated channel should present no more of an obstacle to aquatic animals than the natural channel and not impede the natural movement of floodwater or sediment. The stream simulation technique was first formalized in the Washington Department of Fish and Wildlife's 1999 *Fish Passage Design at Road Culverts* and widely implemented in the Pacific Northwest from the Washington Department of Fish and Wildlife's 2003 *Design of Road Culverts for Fish Passage* (Bates). This approach has since been accepted in New England and is often considered the top industry standard using the approach outlined by the U.S. Forest Service 2008 document, *Stream Simulation: An Ecological Approach to Providing Passage for Aquatic Organisms at Road-Stream Crossings*.
2. Aquatic Organism Passage Design is an approach designed to utilize streambed sediment transport analysis to aid the design for AOP. This approach is outlined by the U.S. Department of Transportation Federal Highway



Memorandum

Administration ("FHWA") publication *Hydraulic Engineering Circular No. 26 (HEC 26)* and typically includes sizing a crossing to the bankfull width times a safety factor. The downside to this approach is that a stream crossing that is designed properly for AOP may or may not account for extreme hydraulic events.

3. Modified Hydraulic Design is the analysis and design of a bridge or culvert based upon hydraulic and structural analyses which account for sufficient flow capacity (including freeboard requirements), bankfull width, channel slopes and natural channel velocities. This method may result in a smaller crossing but requires more detailed hydraulic calculations and may not fully meet AOP criteria.
4. Tradition Hydraulic Design is the design of a bridge or culvert which accounts for flow capacity and regulated required freeboard and does not consider AOP. (Freeboard is the distance between the upstream water elevation and a reference point on the crossing, often the low chord or overtopping elevation.) This approach has been found to have negative impacts to AOP and is more likely to wash out or otherwise fail, therefore, this approach is generally no longer accepted within the discipline.

The four design approaches described above prioritize the various key design criteria differently. Stream simulation design prioritizes the largest number of design criteria and therefore often has the largest crossing footprint and the highest cost. AOP design prioritizes organism passage over other design criteria, which could result in shortcomings regarding hydraulic or structural design. Conversely, the modified hydraulic design approach prioritizes design criteria based on the passage of flood waters and may not fully meet AOP goals. Each of these design approaches varies in upfront design and construction cost. It is important for RIDOT to determine the most efficient manner to allocate future spending by prioritizing key design criteria that will result in reduced long-term expenses, i.e., culvert maintenance, replacement, or retrofits.

Cost Comparison Review

VHB has also researched documents analyzing the long-term cost implications associated with enhanced conveyance and AOP stream crossing design, compared to crossings that are replaced in-kind or based strictly on hydraulics. A reoccurring issue noted by both DOTs and designers is that older culverts damaged during large storm events are usually only funded to be replaced in-kind, requiring the same structure design as prior to the storm event. This results in many undersized culverts being damaged repeatedly and replaced to the same undersized design. The Robert T. Stafford Disaster Relief and Emergency Assistance Act (the Stafford Act) signed into law November 23, 1988 and amended most recently May 2019, provides authority for most Federal disaster response activities, especially as they pertain to Federal Emergency Management Agency (FEMA) programs. This Act outlines the allocation of funding for flood infrastructure, including culvert and bridge design. The most recent (2019) update to this Act states that assistance may be used "to help reduce the risk of future damage, hardship, loss, ... such as: ... modifying or removing culverts to allow drainage to flow freely" and "adding drainage dips and constructing emergency spillways to keep roads and bridges from washing out during floods." The Stafford Act allows DOTs and municipalities to apply for funding beyond replacing structures in-kind, based on a cost-benefit analysis of the various design approaches listed

101 Walnut Street

PO Box 9151

Watertown, MA 02472-4026

P 617.924.1770



Memorandum

above. A cost-benefit analysis for a stream crossing ideally would consider a life cycle assessment that includes the costs associated with design and construction and the benefits of a longer life span and reduced maintenance costs.

VHB's review of cost comparison documents included three articles related directly to this topic and their related conclusions as shown below. Table 2 below summarizes the findings of these articles.

1. *Massachusetts Department of Fish and Game Division of Ecological Restoration ("MA DER"): Economic & Community Benefits from Stream Barrier Removal Projects in Massachusetts Report & Summary (2015)*

This document includes the study of three culverts that were upgraded as an improvement over replacing-in-kind. The study found that on average the improved culvert was 38% less expensive than in-kind replacement and maintenance over 30 years.

2. *Indiana Department of Transportation: Ecologically Aware Design of Waterway-Encapsulating Structures (2016)*

This analysis includes 515 culvert sites across Minnesota, Maine, Vermont and Wisconsin. The study concluded that "reliable data and methodologies for an adequate quantitative analysis [on life-cycle cost analysis] are not yet available." The Indiana DOT examined alternative regulatory schemes based on habitat and biotic integrity indices "because a broad life-cycle costs approach, including social/ecological costs, is unlikely to be available in the foreseeable future." Although there is no conclusion from this study, this provides context for the complexity of this question.

3. *NCHRP 25-25, Task 93: Long-term Construction and Maintenance Cost Comparison for Road Stream Crossings: Traditional Hydraulic Design Vs. Aquatic Organism Passage Design (2017)*

The National Cooperative Highway Research Program ("NCHRP") analysis included a survey of 57 private and public respondents from DOTs and nonprofit organizations. The study reviewed the respondents' data using the Monte Carlo probability simulation to analyze "the capital costs of the AOP design and their effect on the net benefits of each type of culvert." The study concluded that "for a 3-sided box culverts, approximately 80% of the simulations resulted in a net benefit...while for 4-sided box culverts, the percentage grows to approximately 90%. For metal pipes this percentage grows to a nearly 100% of the iterations showing net benefits."



Memorandum

Table 2: Summary of Cost Comparison Article Review

Study	Breadth of Study	Long-Term Saving by accounting for AOP Design compared to Tradition Hydraulic Design
MA DER	3 Culverts	38% Cost Savings
IN DOT	515 Culverts	Inconclusive
NCHRP ¹	Survey of 57 Country wide respondents	<u>3-Sided Box Culverts</u> : 80% Net Benefit to Capital Costs <u>4-Sided Box Culverts</u> : 90% Net Benefit to Capital Costs <u>Metal Pipes</u> : 100% Net Benefit to Capital Costs

Although the Indiana DOT article does not provide a productive conclusion, both Massachusetts and NCHRP found that the improved design, where AOP and other factors are considered, results in a higher upfront cost but savings in the long-term as compared to a replacing-in-kind or traditional hydraulic design. FEMA has also published multiple articles reporting improvement following the culvert replacement in locations where an undersized culvert was previously causing issues for a community; see Appendix A for two examples of FEMA case studies. Based on these findings, VHB agrees that accounting for AOP as an improved design is a worthy investment for long-term cost savings.

Proposed Key Design Standards for RIDOT

Based on the literature review of design criteria, design approaches, and the cost comparison, VHB has compiled a draft set of design standards for the key design criteria shown in Table 3 below. VHB has proposed the following design standards that are most applicable to RIDOT’s current and future road-stream crossing needs. The proposed standards use best practices from other New England states, are based on VHB’s experience with the other stream crossing standards, and are designed to provide cost-efficient, low maintenance, resilient stream-crossings. VHB has provided both “Optimal Standards” and “Base Standards.” Whenever possible, stream crossings should be designed to Optimal Standards to allow for unrestricted movement of wildlife and natural stream processes. In order to achieve Optimal Standards, a bridge should be used to maintain the original natural channel bed with limited alteration or disturbance. However, if site or cost constraints make the use of a bridge impractical, an open bottom structure or culvert may be required. If Optimal Standards cannot be achieved, a stream crossing must meet the minimum Base Standards outlined below.

¹ The NCHRP study utilized a 50-year planning evaluation horizon and the following equations to determine the costs-benefits of the culvert options:

$$\text{Lifetime Costs} = \text{One Time Costs} + \text{Annual Costs}$$

$$\text{Net Benefit/Costs} = \text{Lifetime Costs AOP Culvert} - \text{Lifetime Costs Traditional Culvert}$$



Memorandum

Table 3: Proposed RIDOT Road-Stream Crossing Manual Key Design Standards

Design Criteria ²	Optimal Standards	Base Standards	Primary Sources
Suggested Design Approach	- Stream Simulation	- Stream Simulation, - AOP Design, or - Modified Hydraulic Design	FHWA Design for Fish Passage Stream Simulation - USDA Forest Service
Structure Type	- Bridge, - 3-sided box culverts, - open-bottom culverts, or - arches	- Pipe culvert or - box culvert with embedment (see below)	MA Stream Crossings Handbook
Channel Velocities <i>Assessment Handbook: Section 12: Aquatic Organism Passage</i>	Velocity comparable to natural channel at variety of flows. May also include AOP study to design flow for target species.	Velocity comparable to natural channel at variety of flows.	FHW HEC 26: Culvert Design for AOP
Climate Change <i>Assessment Handbook: Section 7: Climate Change Vulnerability</i>	Design for climate change sea level rise and increased precipitation projections based upon RIDOT Highway Functional Classification.	Design for climate change sea level rise and increased precipitation projections based upon RIDOT Highway Functional Classification.	RIDOT Road-Stream Crossing Assessment Handbook
Crossing Profile <i>Assessment Handbook: Section 8: Geomorphic Impacts Section 12: Aquatic Organism Passage</i>	Crossing profile to match existing natural stream using reference reach.	Crossing profile to match existing natural stream using reference reach to the maximum extent practicable.	Stream Simulation - USDA Forest Service
Embedment <i>Assessment Handbook: Section 12: Aquatic Organism Passage</i>	N/A	Greater than or equal to 2 feet for all structures or 25% for round pipe culverts (whichever is greater).	MA Stream Crossings Handbook Stream Simulation - USDA Forest Service

² The Assessment Handbook note provided in italics describes the applicable assessment section of the Rhode Island DOT Road-Stream Crossing Assessment Handbook.



Memorandum

<p>Openness Ratio</p> <p><i>Assessment Handbook: Section 12: Aquatic Organism Passage</i></p>	<p>Greater than or equal (\geq) to 1.64 feet (0.5 meters) and height \geq 6 feet (1.8 meters)*. If conditions significantly inhibit wildlife, use openness of \geq 2.46 feet (0.75 meters) and height \geq 8 feet (2.4 meters). *Not Required for Tidal Crossings</p>	<p>Greater than or equal to 0.82 feet (0.25 meters) to the maximum extent practicable*. *Not Required for Tidal Crossings</p>	<p>MA Stream Crossings Handbook FHW HEC 26: Culvert Design for AOP USACE New England District Stream Crossing BMPs</p>
<p>Stream Crossing Span</p> <p><i>Assessment Handbook: Section 8: Geomorphic Impacts Section 10: Flood Impact Potential Section 12: Aquatic Organism Passage</i></p>	<p>Greater than or equal 1.2 x BFW with banks on both sides for dry passage for semi-aquatic and terrestrial wildlife.</p>	<p>Greater than or equal to 1.2 x BFW.</p>	<p>MA Stream Crossings Handbook MassDOT Design of Bridges and Culverts</p>
<p>Structural Stability</p> <p><i>Assessment Handbook: Section 9: Structural Condition</i></p>	<p>Design in accordance with Rhode Island and AASHTO LRFD standards. Structural design includes appropriate loading including streamflow, span configuration and freeboard, wingwall layout and design, and footing design. Hydraulic modeling and geotechnical analysis provide direction on foundation requirements and site-specific scour mitigation measures.</p>	<p>AASHTO LRFD Bridge Design Specifications Rhode Island LRFD Bridge Design Manual</p>	
<p>Substrate/Sediment</p> <p><i>Assessment Handbook: Section 8: Geomorphic Impacts Section 12: Aquatic Organism Passage</i></p>	<p>Natural bottom substrate within the structure. Include grain size analysis and bed mobility/stability analysis.</p>	<p>Natural bottom substrate within the structure.</p>	<p>MA Stream Crossings Handbook Stream Simulation - USDA Forest Service</p>
<p>Tidal/Coastal Guidance</p> <p><i>Assessment Handbook: Section 6: Existing Hydraulic Capacity³</i></p>	<p>Designed to accommodate the ebb and flow during high tide or maximum flow conditions and low tide/low flow conditions using a detailed hydraulic analysis.</p>	<p>Designed to accommodate the ebb and flow during high tide or maximum flow conditions and low tide/low flow conditions using a simplified quantitative analysis.</p>	<p><i>VHB's engineering experience</i></p>

³ The RIDOT Assessment Handbook notes this topic but does not provide rating guidance.



Memorandum

Key Methods for Proposed Manual

After reviewing the data above and initial discussions with the RIDOT working team, VHB suggests the following key approaches in beginning to outline the RIDOT Road-Stream Crossing Manual and its proposed design criteria:

1. Build Upon RIDOT Assessment Handbook - The Assessment Handbook includes a significant amount of background information, definitions, and evaluations of many of the key design criteria discussed above. VHB plans to reference material from the Assessment Handbook within the Manual as to not duplicate efforts. The prioritization ranking system from the Assessment Handbook will be incorporated into the Manual as a method to determine the design approach for a project. Using this methodology, crossings with a high *Crossing Risk Score* and/or *Relative Priority Rating* would be required to implement more stringent criteria to provide greater overall benefits including flood resiliency and stream continuity. The individual risk scores from the RIDOT Assessment Handbook (i.e., *Existing Hydraulic Risk Score*, *Climate Change Risk Score*, *Geomorphic Risk Score*, *Structural Risk Score* and *Aquatic Passage Benefit Score*) should each be considered on a case-by-case basis when evaluating replacement and upgrade of stream crossing structures.
2. Design Framework from Regional Stream Crossing Manuals - Design standards for the proposed Manual will have a similar structure and guidance as other regional stream crossing manuals, specifically those from other New England states. The Manual will include two sets of standards, "base" and "optimal", similar to the Massachusetts standards of "general" and "optimum". Providing two levels of standards allows designers to balance ecological and biological objectives with the cost and logistics of crossing design. The specific design criteria (span, openness, embedment, velocity, etc.) are based on the industry standards provided in other regional stream crossing manuals.
3. Structural Design and Considerations - As part of the Manual, VHB plans to include conceptual prototypes of crossing designs prepared in RIDOT standard format. Including conceptual prototypes will provide potential design alternatives to engineers, maintain consistency across designs, and increase the ease of meeting the proposed stream crossing standards. The design drawings will consist of common structure types including pre-manufactured crossing options and common earthwork practices. The designer is still responsible for a structural Bridge Type Study as required by *RIDOT LRFD Bridge Design Manual*; prototypes are meant to be used as a starting point from a hydraulics point of view, all prototypes should still be analyzed for each project specific circumstance.
4. Base Design Requirements upon the RIDOT Highway Functional Classification - VHB plans to incorporate design requirements as a function of the RIDOT Highway Functional Classification. The design requirements will include:
 - Hydraulic Design: Design storm frequency, scour design frequency, and freeboard requirements. Hydraulic design should comply with the *AASHTO Model Drainage Manual* and *FWHA Hydraulic Design Series and Hydraulic Engineering Circulars*.
 - Geotechnical Design: Geotechnical report and boring program requirements.

101 Walnut Street

PO Box 9151

Watertown, MA 02472-4026

P 617.924.1770



Memorandum

- Structural Design: AASHTO design loading, seismic design, and requirements for prefabricated structures.
 - Construction Guidance: Construction details from *RIDOT Bridge Design Standard Details* and *RIDOT Standard Specifications for Road and Bridge Construction* and other applicable AASHTO specifications and details.
 - Submittal Requirements: Hydraulic report, geotechnical report, bridge type study, and final design plans and specifications. If using prefabricated structures, plans and specifications will include design criteria required within submittals of shop drawings and fabricator design calculations.
 - Climate Change: Climate change projection (including sea level rise and increased precipitation) requirements are based upon predications for a future design year. VHB proposes that the design year will be a function of the RIDOT Highway Functional Classification. For example, a stream-crossing carrying an interstate roadway could have a climate change design year of 2120 (or 100 years forward) whereas a stream-crossing carrying a rural roadway may only require a climate change design year of 2050 (or 30 years forward).
5. Retrofit Guidance - VHB plans to include design guidance for retrofitting existing stream crossings. Retrofitting can be a cost-effective approach for improving wildlife passage and may be necessary given site constraints, cost, or other logistics preventing full replacement of a crossing. A crossing could be retrofitted if it is structurally sound, large enough for high flows, if modifications will allow wildlife passage, or if replacement will negatively impact critical wetlands. The guidance will likely include:
- When to replace an existing crossing vs. when to retrofit an existing crossing.
 - Modifications to improve fish passage (grade controls, baffles, weirs, support structures, etc.),
 - Use of RIDOT Assessment Handbook *Crossing Risk Score* and/or *Relative Priority Rating* for determining project design approach.
6. What this Manual is Not:
- *A design guide for stormwater and other drainage pipes.*
 - *A replacement for the RIDOT Bridge Inspection Manual, the RIDOT Linear Stormwater Manual, or the Rhode Island Stormwater Design and Installation Standards Manual:* The proposed Manual is intended to complement, but not replace, other RIDOT and agency manuals.
 - *A guide for structural or geotechnical design and analysis of bridges, arches, or culverts.*
 - *An assessment guide for prioritizing stream crossing replacement:* The proposed Manual is intended to build upon the RIDOT Assessment Handbook.
 - *A Stream Crossing Permitting Guidebook:* This Manual serves as a design guide and does not exclude projects from required permits and regulations. Stream crossing projects may require approval from the following agencies:
 - Rhode Island Department of Environmental Management (RIDEM) Freshwater Wetlands Program
 - Rhode Island Department of Environmental Management (RIDEM) Office of Water Resources

101 Walnut Street

PO Box 9151

Watertown, MA 02472-4026

P 617.924.1770



Memorandum

- Rhode Island Coastal Resources Management Council (CRMC)
- United States Army Corps of Engineers (USACE) Rhode Island Programmatic General Permits
- United States Coast Guard (USCG)
- United States Fish and Wildlife Service (USFWS)
- United States Environmental Protection Agency (USEPA)
- National Marine Fisheries Service (NMFS)
- National Park Service (NPS)

Superseded by the RIDOT
Road-Stream Crossing Manual



Memorandum

Appendix A

FEMA Case Studies

- New Culvert Works: No Flooding at East Street. June 3, 2020
- Wilcox Pond Culvert Upgrade Preventing Roadway Overtopping. June 3, 2020

Superseded by the RIDOT
Road-Stream Crossing Manual



New Culvert Works: No Flooding at East Street

MIDDLESEX COUNTY, MA – Flooding and the closure of East Street, just east of the town center in Tewksbury, Massachusetts, has been an annual – and in some years an even more frequent – event. Yet, when heavy rains in March 2010 brought record-breaking flows to streams across eastern Massachusetts, the floodwaters of Strongwater Brook topped out below the East Street roadway, thanks to recent improvements in the drainage system there.

“The backup of floodwaters at the East Street-Strongwater Brook crossing has long been a problem,” said Brian Gilbert, Superintendent of Public Works in Tewksbury. “So it was good to finally get that resolved last summer (2009).”

Over the past several decades, flooding along the Shawsheen River and its tributary, Strongwater Brook, has overtopped stream crossings on major through streets in Tewksbury. Parts of the town were temporarily isolated, requiring the detour of traffic to alternate routes that quickly became congested, which also severely limited access for emergency response vehicles. In an effort to mitigate the extent and duration of the disruptions caused by flooding of at least one of these streets, town officials proposed to install new, larger culverts at the East Street-Strongwater Brook crossing.

Prior to the reconstruction of the crossing, the brook passed through two old granite culverts, each with an opening of approximately 3 feet by 4 feet. During periods of high flow, the old culverts could not carry all the water, which then backed up and eventually overtopped the roadway. The two new concrete box culverts, each 5 feet high by 10 feet wide, together provide an opening four times larger than the old culverts. As extra insurance against future flooding across East Street, the existing roadway was raised by 3 feet, so that it is now higher than the elevation of the 1-percent-annual-chance flood (known as the 100-year flood) at the crossing.

Because this reach of Strongwater Brook lies within a wetland, proposed drainage improvements had to consider wetlands issues. These include the maintenance of natural water levels and velocities, their fluctuations during periods of low flow, and the accommodation of high flood flows. This dual requirement was resolved by incorporating two features into the design and installation of the new culverts. First, the bottoms of the

culverts were set at 1 foot below the natural channel of the brook and then backfilled to establish a natural channel within the culverts. Secondly, the culverts were sized so that during a flood, water would back up and be temporarily stored in the large wetland area on the upstream side of the roadway. Under such conditions, the water would rise above the tops of the culverts, but not high enough to overtop East Street.

“Completion of the culvert upgrade on East Street last summer made it a lot easier on us during this spring’s (2010) floods,” said Gilbert. “While Main and Shawsheen Streets were flooded and temporarily closed, East Street remained open to traffic throughout the flood. For a while, it was the only direct route into and out of town.”

Drainage improvements at East Street and Strongwater Brook were made possible by a grant from the Federal Emergency Management Agency’s (FEMA’s) Hazard Mitigation Grant Program (HMGP). The HMGP provides 75 percent of the total cost of implementing long-term hazard mitigation measures following major disaster declarations.

For the East Street culvert upgrade project, HMGP provided \$281,250 of the total cost of \$375,000. The \$93,750 remainder of the project cost was the responsibility of the Town of Tewksbury.

Evidence of a former railroad crossing that coincides with the present-day East Street crossing of Strongwater Brook can still be seen at the site, lending a sense of history to the project. A small part of the granite block abutment for the rail crossing is exposed on the downstream side of East Street, and pieces of granite from the old culverts and the abutment have been placed for erosion protection on the embankments on both sides of the street adjacent to the new culverts

Tags: ● [Region I](#) ● [Massachusetts](#) ● [Hazard Mitigation](#)

Last updated June 3, 2020

[Accessibility](#) [Accountability](#) [Careers](#) [Contact Us](#) [FOIA](#) [Glossary](#) [No FEAR Act](#)

[Plug-Ins](#) [Privacy](#) [Report Disaster Fraud](#) [Website Information](#) [DHS.gov](#) [USA.gov](#)

[Inspector General](#)





Wilcox Pond Culvert Upgrade Preventing Roadway Overtopping

BIDDEFORD, ME - During large rain events, West Street, a major road in Biddeford, has had to be shut down. The area of West Street by the Wilcox Pond outflow culvert overtops during these events causing washout and structural damage to the road bed. In addition to the loss of road access, the washout creates a 7 mile detour for public safety vehicles and the potential for threats to the safety and health of the residents.

The City decided that upgrading the drainage capacity of the outflow culvert at Wilcox Pond could reduce the potential for overtopping the roadway. Funds from the Hazard Mitigation Grant Program (HMGP) were awarded for this project in November 1997. In the process of upgrading the culvert, the City reset the culvert angle to permit direct outflow downstream. In addition, the City installed rip-rap on the banks to reduce erosion. The City also changed the slope of the roadway to provide easy runoff.

The project was completed in May 1998. In June 1998, more than 10 inches of heavy rain caused flooding across southern Maine. The Wilcox Pond Culvert area was not damaged and remained open to traffic. Savings in avoided damages from the June 1998 and subsequent flooding events over the life of this mitigation project are estimated to be \$230,000.

Standard Homeowner's insurance policies do not cover flood damage. The National Flood Insurance Program makes Federally backed flood insurance available to homeowners, renters, and business owners in participating communities.

Tags: ● [Region I](#) ● [Maine](#) ● [Hazard Mitigation](#)

Last updated June 3, 2020



Memorandum

References

- AASHTO Standing Committee on Environment & Subcommittees on Construction and Maintenance. (n.d.). *Environmental Stewardship Practices in Construction and Maintenance Compendium, Chapter 3.5 Culverts and Fish passage*. Center for Environmental Excellence by AASHTO. Retrieved November 11, 2020, from https://environment.transportation.org/environmental_issues/construct_maint_prac/compendium/manual/3_5.aspx
- Barnard, B. (2003). *Evaluation of the Stream Simulation culvert design method in Western Washington, a preliminary study*. Washington Department of Fish and Wildlife. <https://wdfw.wa.gov/sites/default/files/publications/00060/wdfw00060.pdf>
- Barnard, R. J., Johnson, J., Brooks, P., Bates, K. M., Heiner, B., Klavas, J. P., Ponder, D.C., Smith, P.D., & Powers, P. D. (2013). *Water crossings design guidelines*. Washington Department of Fish and Wildlife. <https://wdfw.wa.gov/sites/default/files/publications/01501/wdfw01501.pdf>
- Bates, K. (1999). *Fish Passage Design at Road Culverts*. Washington Department of Fish and Wildlife. <http://docs.streamnetlibrary.org/Protocols/103.pdf>
- Bates, K. (2003). *Design of Road Culverts for Fish Passage*. Washington Department of Fish and Wildlife. https://www.fs.fed.us/biology/nsaec/fishxing/fplibrary/Bates%20and%20others_2003_culvert_manual_final.pdf
- Bates, K. & Kirn, R. (2009, March). *Guidelines for the Design of Stream/Road Crossings for Passage of Aquatic Organisms in Vermont*. Vermont Department of Fish and Wildlife & the Vermont Transportation Agency. http://54.172.27.91/transportation/AOP/VDFW_GuidelinesDesignRoadXings_AOP_200903.pdf
- Becker, S., Jackson, S., Jordaan, A., & Roy, A. (2018). *Impacts of Tidal Road-Stream Crossings on Aquatic Organism Passage*. U.S. Department of Interior, Fish and Wildlife Service, Cooperator Science Series FWS/CSS-131-2018. <https://streamcontinuity.org/sites/streamcontinuity.org/files/pdf-doc-ppt/Tidal%20Crossing%20USGS%20Report.pdf>
- California Department of Transportation (CalTrans). (2007, May). *Fish Passage Design for Roadway Crossing Guidance*. Retrieved November 11, 2020, from <https://dot.ca.gov/programs/design/manual-fish-passage-design-for-roadway-crossings>
- Dexter, T. & Nyman, D. (2016, September 12). *Massachusetts Department of Transportation Stream Crossing Handbook*. Northeastern Transportation & Wildlife Conference. https://www.netwc.org/uploads/2/0/9/4/20948254/tim_dexter.pdf



Memorandum

- Federal Emergency Management Agency. (May 2019). *Stafford Act, as Amended, and Related Authorities: Homeland Security Act, as amended (Emergency Management-related Provisions)*.
<https://www.fema.gov/disasters/stafford-act>
- Federal Emergency Management Agency. (2020a, June 3). *New Culvert Works: No Flooding at East Street*.
<https://www.fema.gov/node/454130>
- Federal Emergency Management Agency. (2020b, June 3). *Wilcox Pond Culvert Upgrade Preventing Roadway Overtopping*. <https://www.fema.gov/node/454976>
- Federal Highway Administration. (2007, June). *Design for Fish Passage at Roadway-Stream Crossings: Synthesis Report* (FHWA-HIF-07-033). U.S. Department of Transportation.
<https://www.fhwa.dot.gov/engineering/hydraulics/pubs/07033/07033.pdf>
- Federal Highway Administration. (2010, October). *Culvert Design for Aquatic Organism Passage* (Hydraulic Engineering Circular No. 26, First Edition, Publication No. FHWA-HIF-11-008). U.S. Department of Transportation.
<https://www.fhwa.dot.gov/engineering/hydraulics/pubs/11008/hif11008.pdf>
- Forest Service Stream-Simulation Working Group (FSSSWG). (2008, August). *Stream Simulation: An Ecological Approach to Providing Passage for Aquatic Organisms at Road-Stream Crossings*. U.S. Department of Transportation, Federal Highway Administration Coordinated Federal Lands Highway Technology Implementation Program. https://www.fs.fed.us/eng/pubs/pdf/StreamSimulation/hi_res/%20FullDoc.pdf
- Greenwood, J. (2017). *Municipal Climate Adaptation Guidance Series: Stream Smart Crossings*. Municipal Planning Assistance Program of the Maine Department of Agriculture Conservation and Forestry.
https://www.maine.gov/dacf/municipalplanning/docs/CAGS_02A_StreamSmart%20Crossings.pdf
- Hernick, M., Lenhart, C., Kozarek, J., & Nieber J. (2019, January). *Minnesota Guide for Stream Connectivity and Aquatic Organism Passage through Culverts*. (Report No. MN/RC 2019-02). Minnesota Department of Transportation, Research Services & Library. <https://files.dnr.state.mn.us/waters/publications/culvert-stream-connectivity.pdf>
- Inland Fisheries Division Habitat Conservation and Enhancement Program. (2008, February 26). *Stream Crossing Guidelines*. Connecticut Department of Environmental Protection. <https://portal.ct.gov/-/media/DOT/finalcrossingguidelinesFeb262008highrespdf.pdf>
- Interagency Wild and Scenic Rivers Coordinating Council. (2018, July). *A Compendium of Frequently Asked Questions Relating to Transportation & Infrastructure Projects*.
<https://www.rivers.gov/transportation/documents/transportation-q-a.pdf>



Memorandum

- Jackson, S.D. (2019, August 23). *NAACC Tidal Stream Crossing Instruction Manual for Aquatic Passability Assessments*. North Atlantic Aquatic Connectivity Collaborative (NAACC), University of Massachusetts Amherst. https://streamcontinuity.org/sites/streamcontinuity.org/files/pdf-doc-ppt/NAACC_Instructions%20for%20Tidal%20Crossings%208-23-19_0.pdf
- The Louis Berger Group Inc. (2017, March). *NCHRO 25-25, Task 93: Long-term Construction and Maintenance Cost Comparison for Road Stream Crossings: Traditional Hydraulic Design vs. Aquatic Organism Passage Design*. AASHTO Standing Committee on Environment. [http://onlinepubs.trb.org/onlinepubs/nchrp/docs/NCHRP25-25\(93\)_FR.pdf](http://onlinepubs.trb.org/onlinepubs/nchrp/docs/NCHRP25-25(93)_FR.pdf)
- Lyn, D. A., & Sangwan, N. (2016). *Ecologically Aware Design of Waterway-Encapsulating Structures* (Joint Transportation Research Program Publication No. FHWA/IN/JTRP-2016/21). West Lafayette, IN: Purdue University. <https://doi.org/10.5703/1288284316344>
- Maine Department of Transportation. (2004, March). *Fish Passage Policy & Design Guide*. https://www.fs.fed.us/biology/nsaec/fishxing/fplibrary/MDOT_2004_Fish_Passage_Policy_and_Design_Guide.pdf
- Maine Department of Transportation. (2008, July). *Waterway and Wildlife Crossing Policy and Design Guide for Aquatic Organism, Wildlife Habitat, and Hydrologic Connectivity* (3rd Edition). https://digitalmaine.com/mdot_docs/8
- Massachusetts Department of Fish and Game Division of Ecological Restoration (2015, March). *Economic & Community Benefits from Stream Barrier Removal Projects in Massachusetts*. <https://www.mass.gov/doc/phase-3-economic-community-benefits-from-stream-barrier-removal-projects-in-massachusetts/download>
- Massachusetts Department of Fish and Game Division of Ecological Restoration. (2018). *Massachusetts Stream Crossings Handbook*. <https://www.mass.gov/doc/massachusetts-stream-crossing-handbook/download>
- Massachusetts Department of Transportation Highway Division. (2010, December). *Design of Bridges and Culverts for Wildlife Passages at Freshwater Streams*. https://roadecology.ucdavis.edu/files/content/projects/MA_DOT_Design_Bridges_Culverts_Wildlife_Passage_12_2710.pdf
- Massachusetts Department of Transportation Highway Division. (2019). *DRAFT - Stream Crossing Handbook*.
- National Marine Fisheries Service & Federal Highway Administration. (2018, April). *Best Management Practices Manual for Transportation Activities in the greater Atlantic Region*. Retrieved November 11, 2020, from <https://www.fisheries.noaa.gov/new-england-mid-atlantic/consultations/section-7-take-reporting-programmatics-greater-atlantic>



Memorandum

- New Hampshire Department of Environmental Services Wetlands Bureau. (n.d.). *Streams and Stream Crossings*. Retrieved November 11, 2020, from https://www.des.nh.gov/organization/divisions/water/wetlands/streams_crossings.htm
- New York State Department of Environmental Conservation. (n.d.) *Stream Crossings: Guidelines and Best Management Practices*. Retrieved November 11, 2020, from <https://www.dec.ny.gov/permits/49066.html>
- North Atlantic Aquatic Connectivity Collaborative. (n.d.). Retrieved November 11, 2020, from <https://streamcontinuity.org/naacc>
- Nyman, D. (2018, September 12). *Where the River Meets the Road: MassDOT's Stream Crossing Handbook*. Northeastern Transportation & Wildlife Conference. https://www.netwc.org/uploads/2/0/9/4/20948254/nyman_wed.pdf
- Reed, D.F., Woodard, T.N., & Beck, T.D. (1979). *Regional Deer-Vehicle Accident Research*. Federal Highway Administration. Rep. No. FHWA-RD-79-11.
- Rhode Island Coastal Resources Management Council & URI Coastal Resources Center. (n.d.). *RI Shoreline Change Special Area Management Plan*. Retrieved November 11, 2020, from <http://www.beachsamp.org/>
- Rhode Island Coastal Resources Management Council. (2018, December 12). *Rules and Regulations Governing the Protection and Management of Freshwater Wetlands in the Vicinity of the Coast: 650-RICR-20-00-2*. [http://www.crmc.ri.gov/regulations/Fresh Water Wetlands.pdf](http://www.crmc.ri.gov/regulations/Fresh_Water_Wetlands.pdf)
- Rhode Island Department of Environmental Management Freshwater Wetlands Program. (2010, April). *Wetland BMP Manual: Techniques for Avoidance and Minimization*. Retrieved November 11, 2020, from <http://www.dem.ri.gov/programs/water/permits/wetbmp.php>
- Rhode Island Department of Environmental Management. (2010, December). *Water Quality Regulations*. <http://www.dem.ri.gov/pubs/regs/regs/water/h20q09a.pdf>
- Rhode Island Department of Environmental Management. (2014, July 16). *Rules and Regulations Governing the Administration and Enforcement of the Fresh Water Wetlands Act*. <http://www.dem.ri.gov/pubs/regs/regs/water/wetlnd14.pdf>
- Rhode Island Department of Transportation. (2007). *Rhode Island LRFD Bridge Design Manual*. <http://www.dot.ri.gov/documents/doingbusiness/RILRFDBridgeManual.pdf>
- Rhode Island Department of Transportation. (2015, July 21). *Bridge Design Standard Details*. [http://www.dot.ri.gov/documents/doingbusiness/RIDOT Bridge Standards.pdf](http://www.dot.ri.gov/documents/doingbusiness/RIDOT_Bridge_Standards.pdf)



Memorandum

- Rhode Island Department of Transportation. (2018, March). *Standard Specifications for Road and Bridge Construction*. <http://www.dot.ri.gov/documents/doingbusiness/bluebook.pdf>
- Rhode Island Department of Transportation. (2019, August). *Road-Stream Crossing Assessment Handbook*. [http://www.dot.ri.gov/documents/about/protecting/stormwater/RIDOT Road-Stream Crossing Assessment Handbook.pdf](http://www.dot.ri.gov/documents/about/protecting/stormwater/RIDOT_Road-Stream_Crossing_Assessment_Handbook.pdf)
- River and Stream Continuity Partnership. (2011, March 1). *Massachusetts River and Stream Crossing Standards*. https://www.nae.usace.army.mil/Portals/74/docs/regulatory/StreamRiverContinuity/MA_RiverStreamCrossingStandards.pdf
- State of Maine Aquatic Resources Management Strategy Forum. (n.d.). *Stream Smart Pocket Guide*. https://www.maine.gov/mdot/publications/docs/brochures/pocket_guide_stream_smart_web.pdf
- University of New Hampshire. (2009, May). *New Hampshire Stream Crossing Guidelines*. <https://www.des.nh.gov/organization/divisions/water/wetlands/documents/nh-stream-crossings.pdf>
- US Army Corps of Engineers, New England District. (2015, January). *Stream Crossing Best Management Practices (BMPs)*. <https://www.nae.usace.army.mil/Portals/74/docs/regulatory/StateGeneralPermits/NEGP/BMPStreamCrossings21Jan2015.pdf>
- US Army Corps of Engineers, New England District. (2018, August 15). *Errata Sheet for the Rhode Island General Permits*. <https://www.nae.usace.army.mil/Portals/74/docs/regulatory/StateGeneralPermits/RI/RIGP-w-erratasheet.pdf>
- Wood-Pawcatuck Wild and Scenic Study Committee. (2018, June). *Wood-Pawcatuck Wild and Scenic Rivers Stewardship Plan for the Beaver, Chipuxet, Green Fall-Ashaway, Pawcatuck, Queen-Usquepaugh, Shunock, and Wood Rivers*. <http://wpwildrivers.org/wp/wp-content/uploads/2018/09/WandSStewardshipPlanFINAL.pdf>



Appendix F:

Diadormous Fish Passage Guidelines

Technical Memorandum

Federal Interagency Nature-like Fishway Passage Design Guidelines for Atlantic Coast Diadromous Fishes



May 2016



Technical Memorandum
Federal Interagency Nature-like Fishway Passage Design Guidelines
for Atlantic Coast Diadromous Fishes

May 2016

James Turek¹, Alex Haro², and Brett Towler³

¹NOAA National Marine Fisheries Service, Narragansett, RI

²U.S. Geological Survey S.O. Conte Anadromous Fish Research Center, Turners Falls, MA and

³U.S. Fish and Wildlife Service, Hadley, MA

Abstract: The National Marine Fisheries Service (NMFS), the U.S. Geological Survey (USGS) and the U.S. Fish and Wildlife Service (USFWS) have collaborated to develop passage design guidance for use by engineers and other restoration practitioners considering and designing nature-like fishways (NLFs). The primary purpose of these guidelines is to provide a summary of existing fish swimming and leaping performance data and the best available scientific information on safe, timely and effective passage for 14 diadromous fish species using Atlantic Coast rivers and streams. These guidelines apply to passage sites where complete barrier removal is not possible. This technical memorandum presents seven key physical design parameters based on the biometrics and swimming mode and performance of each target fishes for application in the design of NLFs addressing passage of a species or an assemblage of these species. The passage parameters include six dimensional guidelines recommended for minimum weir opening width and depth, minimum pool length, width and depth, and maximum channel slope, along with a maximum flow velocity guideline for each species. While these guidelines are targeted for the design of step-pool NLFs, the information may also have application in the design of other NLF types being considered at passage restoration sites and grade control necessary for infrastructure protection upstream of some dam removals, and in considering passage performance at sites such as natural bedrock features.

How to cite this document: Turek, J., A. Haro, and B. Towler. 2016. Federal Interagency Nature-like Fishway Passage Design Guidelines for Atlantic Coast Diadromous Fishes. Interagency Technical Memorandum. 47 pp.

Disclaimer: The efficacy of any fish passage structure, device, facility, operation or measure is highly dependent on local hydrology, target species and life history stage, barrier orientation, and a myriad of other site-specific considerations. The information provided herein should be regarded as generic guidance for the design of NLFs for the Atlantic Coast of the U.S. The guidelines described are not universally applicable and should not replace site-specific recommendations, limitations, or protocols. This document provides generic guidance only and is not intended as an alternative to proactive consultation with any regulatory authorities. The use of these guidelines is not required by NMFS, USFWS or USGS, and their application does not necessarily imply approval by the agencies of any site-specific design.

Table of Contents

Introduction.....1

Rationale for Passage Guidelines.....3

Existing Fish Passage Design Criteria and Guidance.....4

Federal Interagency Guidance with Science-Based Application.....5

Target Species.....6

Run Timing and Passage Flows.....7

Body Morphology, Swimming and Leaping Capabilities and Behaviors.....7

Federal Interagency Passage Design Guidance.....9

General Design Rationale.....9

Species-Specific Rationales.....20

References.....40

List of Figures

Figure 1. Plan view, cross section, and profile illustrations of physical features and nominal measures relating to passage design guidelines for a typical boulder step-pool fishway.....10

Figure 2. Captioned photographs of constructed nature-like fishways (NLFs) for passage by Atlantic coast diadromous fishes.....19

List of Tables

Table 1. Atlantic coast diadromous fish species, common and scientific names.....6

Table 2. Summary of design guidelines for NLFs and related to swimming capabilities and safe, timely and efficient passage for Atlantic coast diadromous fish species.....18

Acknowledgements

The authors greatly appreciate assistance provided by others in completing this guidance document. Melissa Belcher, graduate of the University of Massachusetts Amherst, Department of Natural Resources with MS degree in Environmental Conservation, completed the initial literature search and review, field data collection at multiple nature-like fishway sites in the Northeast, and synthesis of each Northeast site. Species-specific information and guideline development input were provided by Luther Aadland (MN DNR), Ted Castro-Santos (USGS), Chris Chambers (NMFS), Brad Chase (MA DMF), Claire Enterline (ME DMR), Mark Gallagher (ME DIFW), Steve Gephard (CT DEEP), Micah Kiefer (USGS), Tim Sheehan (NMFS), and Sara Turner (MA DMF). Technical reviews of earlier document drafts were kindly provided by: NOAA: Mary Andrews, Matt Bernier, John Catena, Matt Collins, Don Dow, Eric Hutchins, Bjorn Lake, Sean McDermott, and Rory Saunders; USFWS: Mike Bailey, Curt Orvis, and Ken Sprankle; and USGS: John Beeman and John Noreika.

Introduction

Diadromous fishes spend portions of their lives in marine, estuarine and freshwater environments and migrate great distances throughout their life cycles. All diadromous fish species require unimpeded access between their rearing and spawning habitats. Diadromous fishes that use freshwater rivers and streams of the Atlantic Coast of the U.S. as spawning habitats include a diverse anadromous species assemblage, and the catadromous American eel (*Anguilla rostrata*) which spends much of its life in freshwater rearing habitat with adults out-migrating to spawn in the Sargasso Sea. These fishes deliver important ecosystem functions and services by serving as forage for higher trophic-level species in both marine and freshwater food webs (Collette and Klein-MacPhee 2002; Ames 2004; McDermott et al. 2015) and providing an alternative prey resource (i.e., prey buffer benefitting other species) to predators in estuaries and the ocean (Saunders et al. 2006). In rivers and streams, services provided by this diadromous fish assemblage include relaying energy and nutrients from the marine environment (Guyette et al. 2013), transferring energy within intra-species life stages in streams (Weaver 2016), providing benthic habitat nutrient conditioning and beneficial habitat modification (Brown 1995; Nislow and Kynard 2009; West et al. 2010), serving as hosts to disperse and sustain populations of freshwater mussel species (Freeman et al. 2003; Nedeau 2008), and enhancing stream macro-invertebrate habitat (Hogg et al. 2014).

Diadromous fishes are also recognized in contributing significant societal values. Historically, Native Americans, European colonists, and post-settlement America relied heavily on these species as sources of food and for other uses (McPhee 2003). Many of these diadromous fish species are highly valued in supporting commercial and recreational fisheries, with some species prized as sportfish and/or food sources including culinary delicacies (Greenberg 2010). They also contribute to important passive recreational opportunities where people can observe spring fish runs, learn about their life histories, and appreciate these migratory fishes and their key roles in riverine, estuarine and marine ecosystems (Watts 2012).

Many populations of Atlantic Coast diadromous fishes have been in serious decline for decades due to multiple factors including hydro-electric dams and other river barriers preventing access to spawning and rearing habitats, water and sediment quality degradation, overharvesting, parasitic infestations and other fish health effects, body injuries due to boat strikes and other human-induced impacts (Limburg and Waldman 2009; Hall et al. 2011; Waldman 2014). Shortnose sturgeon (*Acipenser brevirostrum*), Atlantic salmon (*Salmo salar*), and Atlantic sturgeon (*Acipenser oxyrinchus oxyrinchus*) (NMFS 1998, 2009, 2013a) have been designated as endangered under the Endangered Species Act (ESA) (Atlantic sturgeon are currently listed as threatened in the Gulf of Maine). American eel were recently considered for listing under the ESA (USFWS 2011, 2015) and are currently designated as a Species of Concern. Both alewife (*Alosa pseudoharengus*) and blueback herring (*Alosa aestivalis*) were designated as Species of Concern in 2006 (NMFS 2006), and NMFS was petitioned in 2011 to list both as ESA species. NMFS completed its review for the candidate ESA listing in 2013 and determined that listing either river herring species was not warranted as either threatened or endangered. NMFS continues to collect and assess monitoring data on the status of populations and abundance

trends of and threats to each river herring species (NMFS 2013b). Rainbow smelt (*Osmerus mordax*) were also previously designated by NMFS as a Species of Concern (NMFS 2007).

To address these precipitously declining diadromous fish populations, pro-active restoration has been implemented by many agencies and non-governmental organizations to help restore diadromous fish runs by removing dams and other barriers, installing technical and nature-like fishways, or a combination of these passage restoration alternatives (NOAA Fisheries 2009, 2012; Schrack et al. 2012). Improving habitat access through dam removal and other measures may also contribute to diadromous species recolonizing historic freshwater habitats and increasing abundance and distribution of target species locally (Pess et al. 2014). Federal regulatory programs also seek to minimize upstream and downstream mortality of diadromous fishes passing hydro-electric dams or other river and stream barriers by requiring mitigative passage measures (e.g., ASMFC 2008, 2010; NOAA Fisheries 2012, 2015).

The NMFS and USFWS have well-established programs to address diadromous restoration by providing funds for and/or technical assistance in the planning, design and implementation of fish passage restoration (See NOAA site: <http://www.habitat.noaa.gov/restoration/approaches/fishpassage.html>; and USFWS site: <https://www.fws.gov/northeast/fisheries>). Both NMFS and USFWS along with USGS seek to advance engineering design and technology in providing safe (from both physical injury and predator avoidance), timely, and effective upstream and downstream passage for all diadromous species targeted for restoration. At many passage barrier sites, complete removal of the obstruction presents the best alternative for restoring diadromous fish passage and watershed populations (ASMFC, 2009; Martin and Aspe 2011; NOAA Fisheries 2012).

For sites where barriers cannot be fully removed or modified, other passage alternatives can be considered. Nature-like fishways (NLFs) include a wide variety of designs such as step-pools, roughened ramps, rock-arch rapids, rocky riffles, and cross vanes which are typically constructed of boulders, cobble, and other natural materials to create diverse physical and hydraulic conditions providing efficient passage to multiple species including migratory and resident fish assemblages. NLFs also provide greater surface roughness and flow complexity than typical technical (or structural) fishways (e.g., Denil, steep-pass fishways), creating attractive flow cues to passing fish. Interstitial spaces and surface irregularities associated with NLFs also provide cover and spawning microhabitats, which may be particularly important in watersheds where these specific habitats are limited. The use of natural materials in NLFs such as fieldstone boulders and cobble is also beneficial in lessening the likelihood of fish injury from sharp-edge structures such as those typically associated with structural fishways. NLF designs such as partial or full-river width or bypass channels around barriers can result in effective passage if appropriately designed and constructed for passing fish over a wide range of flows throughout the anticipated seasonal run period for a target species or run periods for targeted fish species assemblage.

Rationale for Passage Guidelines

Fish passage guidelines contribute to best design practices, promote design consistency, and facilitate time and cost-efficiency and quality in engineering design of NLFs and related passage supporting ecological restoration of river systems. NMFS, USGS and USFWS initiated a collaborative effort in 2010 to compile and review existing information from published journals, reports and other unpublished literature on body dimensions and the swimming and leaping capabilities of 14 Atlantic Coast diadromous fish species, and passage and hydraulic functioning of existing fishways. Published data on critical swim speed for each species were also secured, when available. NMFS also organized and held a technical workshop including fish passage biologists and engineers from USGS, USFWS, NMFS and state agencies experienced with diadromous fish passage in the Northeast region to discuss knowledge and experiences in species passage success and challenges (NMFS, Gloucester, MA; February 11, 2010). Subsequent federal agency meetings were held and follow-up consultations were made with professionals from state agencies, academia, and private industry to secure supplemental information on the biology of these target species and their experience with and data available for or analysis of fish swimming performance and/or passage evaluation of the Atlantic Coast diadromous fish species.

Compiling and assessing species data and information from experts with knowledge of the species and field and flume laboratory experiences, NMFS, USGS and USFWS applied the collective dataset in developing science-based guidelines when fish swimming and leaping data were available, or best professional judgment when scientific data were limited or unavailable. Best professional judgment is defined herein as personal observations and/or unpublished data provided by experienced fishery professionals knowledgeable of the swimming and leaping capabilities and behaviors of one or more of the target species.

Compiled information includes the ranges in body length and depth for each of the 14 target diadromous species, to derive body depth-to-total length ratios. These data were then applied in developing a set of six dimensional guidelines for designing passage openings and resting pools. To date, swim speed data from controlled respirometer experiments are available for 10 of the 14 species. Swim data from controlled open-channel swimming flume experiments were available for 8 of the 14 species (data for shortnose sturgeon and Atlantic salmon from USGS Conte Laboratory open flume are forthcoming). Swimming performance data from both respirometer and open-channel swimming flume research was then used to derive maximum through-weir velocity guidelines for each species. Where performance data for a species are minimal, more conservative estimates have been applied in developing the guidelines. The rationales for the guidelines presented in this document include published references or other source of information, as indicated; otherwise, guidelines presented herein are based on best professional judgment.

These guidelines are primarily for purposes of informing the design of NLFs, and in particular, nature-like, step-pool fishways that include resting pools formed by boulder weirs with passage notches specifically designed for the intended target species. One or more of these passage

guidelines may also have application to other types of NLFs. These guidelines may also be considered for application in evaluating potential passage alternatives at low-head dams and other barrier sites (e.g., flow diversion and gauging station weirs) and in designing grade control structures upstream of potential dam removals to improve fish passage and/or to protect upstream infrastructure (e.g., bridges and utilities buried in channel bed and bordering floodplain). At some dam removal sites, passage design features may be required upstream of barrier removals to take into account channel bed adjustments which may otherwise result in exposure of and damage to existing infrastructure and/or re-exposure of natural bedrock features. These guidelines may also have application for assessing the likelihood of safe, timely and effective passage at existing natural barriers considered in the context of passage restoration throughout a watershed. As additional studies on fish swimming performance and fish passage effectiveness are completed, these guidelines may be subject to further updates and revisions.

Existing Fish Passage Design Criteria and Guidance

During development of these guidelines, a thorough review was conducted to evaluate other efforts in establishing criteria for fish passage design. To date, a science-based application of fish body morphology, swimming and leaping capabilities, and behavior for passage design has been limited, with most early studies and publications focused on salmonid passage through culverts in the U.S. Pacific Northwest (as summarized in Orsborn 1987). Bell (1991) presents a synopsis of biological requirements of a limited number of fish species which are then applied to developing biological design guidance including swimming speeds of both juvenile and adult life stages; the published swimming speeds are based primarily on limited and non-standardized experimental methods. Clay (1995) provides an overview of fishway types and examples of installed technical fishways on the Atlantic Coast of North America and elsewhere, with passage guidance that targets hydraulics over weirs, through slots or orifices, and in resting pools which are related to varying fish swims speeds. Beach (1984) and Pavlov (1989) note that body length and water temperature influence swim speeds which in turn help to define passage design guidance.

The Food and Agriculture Organization (FAO 2002) released guidance on European upstream fish passage design, as a follow-up to a 1996 publication prepared by the German Association for Water Resources and Land Improvement ('DVWK'). The FAO document addresses general fish body size and swim speed of a number of European species, along with designated river "fish zones" in which diadromous and resident fishes are found. The FAO guidance also addresses both nature-like and technical fishways, and general design and detailed guidelines for, and completed examples of (e.g., design dimensions, construction materials and fishway sizes) nature-like fishways. The FAO document is the first guidance for nature-like fishway design, taking into account the swimming and leaping capabilities of fishes.

The Maine DOT (2008) presents both a fish passage policy and design guidelines for passage of diadromous and freshwater fishes through culverts including a minimum-depth guideline applied to low flows, and a maximum-flow velocity guideline based primarily on body-length

derived from sustained swimming speeds of target species. The Maine DOT guidance does not address design guidance for fishways. Similar culvert design guidance was released by the Vermont DFW (2009) discussing Atlantic salmon and resident freshwater species biometric and swimming information for passage design including maximum jump height, and a minimum passage water depth of 1.5 times the maximum body depth of the target species. Other states (Washington, California) have released guidance materials for anadromous fish passage design of culverts (Bates et al. 2003, California Department of Fish and Game 2009). The guidelines for velocity and jump height thresholds in these design documents are typically intended to provide passage conditions for the weakest fishes and smallest individuals of each species, while the minimum passage depth guideline for a species is based on the largest-sized fish expected to pass.

There are several sources of passage design for the construction of nature-like fishways. NMFS' Northwest Region provides guidance for passage specifically for Pacific salmonids (primarily genus *Oncorhynchus*) (NMFS 2008, updated 2011), with fish biological requirements and specific design guidelines (prescriptive unless site-specific, biological rationale is provided and accepted by NMFS) and general guidelines (specific values or range in values that may vary when site-specific conditions are taken into consideration) to address a variety of passage types including both technical fishways and nature-like ramps. Aadland (2010) addresses dam removal and nature-like structures for achieving fish passage targeting Mid-Western region warm and cool water fish assemblages, with nature-like fishways serving as features to emulate natural rapids and providing a range of passage conditions and in-fishway habitats benefitting diverse fish assemblages with varying species' swimming capabilities. The document also presents a review of engineering design practices for rock ramp, rock arch rapids and bypass channels. The U.S. Department of Interior's Bureau of Reclamation (Mooney et al. 2007) provides detailed guidelines for nature-like rock ramp design, although species-specific body metrics and swimming and leaping requirements are not addressed in detail.

This existing published passage guidance literature contributes valuable input on how criteria and guidelines have been developed for a number of fish species and variety of fish assemblages and river systems. Conversely, none of the guidelines are targeted specifically for Atlantic Coast diadromous fishes which each have specific body morphology and swimming and leaping capabilities. NMFS, USGS and USFWS thus seek to provide a set of guidelines addressing this diadromous fish assemblage for use by passage restoration practitioners.

Federal Interagency Guidance with Science-Based Application

As noted above, the federal interagency team reviewed and evaluated relevant published journal articles, reports and gray literature, summarized and selected more recent data gained through controlled experiments (e.g., USGS Conte Anadromous Fish Laboratory and other open channel flumes), utilized past performance data from constructed NLFs (primarily in the Northeast), and advanced hydraulic formulae pertinent to nature-like fishway design (e.g., SMath model; See Towler et al. 2014) to develop these science-based guidelines. These guidelines are intended to benefit passage design professionals with information to provide

safe, timely and effective passage for Atlantic Coast diadromous fish species targeted in using step-pool and other NLFs.

Target Species

Biological information has been compiled and evaluated for fourteen diadromous species in developing these passage design guidelines. The species addressed in this memorandum include species endemic to the Atlantic Coast. The species are listed according to an evolutionary taxonomic hierarchy (**Table 1**). While not currently addressed by this document, other anadromous (e.g., sticklebacks), amphidromous, and/or potamodromous fish species may be added in future interagency updates, as more research-based swimming and leaping performance data become available and are evaluated.

Table 1. Atlantic Coast Diadromous Fish Species, Common and Scientific Names

<u>Common Name</u>	<u>Scientific Name</u>
Sea lamprey	<i>Petromyzon marinus</i>
Shortnose sturgeon	<i>Acipenser brevirostrum</i>
Atlantic sturgeon	<i>Acipenser oxyrinchus oxyrinchus</i>
American eel	<i>Anguilla rostrata</i>
Blueback herring	<i>Alosa aestivalis</i>
Alewife	<i>Alosa pseudoharengus</i>
Hickory shad	<i>Alosa mediocris</i>
American shad	<i>Alosa sapidissima</i>
Gizzard shad	<i>Dorosoma cepedianum</i>
Rainbow smelt	<i>Osmerus mordax</i>
Atlantic salmon	<i>Salmo salar</i>
Sea-run brook trout	<i>Salvelinus fontinalis</i>
Atlantic tom cod	<i>Microgadus tomcod</i>
Striped bass	<i>Morone saxatilis</i>

The species diversity and abundance of a species within a watershed targeted for restoration depends on the river size or stream order, although other factors, particularly the number and location of passage barriers in a watershed will influence passage restoration planning. Fish passage engineers and other practitioners should consult with fishery biologists familiar with existing diadromous fish populations and historic run data on a regional basis and with the watershed targeted for restoration to secure reliable species and meta-population-specific information on run timing and projected restored run size for each targeted species. Information should include the range of earliest to latest dates of passage, including documented or anticipated earlier season runs or truncated run periods due to climatic change effects on in-stream water temperatures and/or peak discharges. The identification and agreement on the target species to be restored in a watershed and passed at a proposed

restoration site should be a principal project objective and central to the initial step in the design process (See Palmer et al. 2005).

Run Timing and Passage Flows

Seasonal timing of fish migrations is a key consideration in fishway design, and needs to be thoroughly considered in determining fish passage design flows and fishway discharge. Fish run timing is often highly variable throughout each species' geographical range, between watersheds, and over years. Run timing, encompassing the beginning, peak, and end of a fish species migratory run period (or spring and fall run periods), is influenced by multiple factors. These factors include genetics; environmental conditions such as precipitation and other weather events and patterns; freshwater, estuarine or oceanic conditions; river flows including the effects of hydro-electric impoundment releases or water withdrawals; in-stream turbidity, dissolved oxygen levels and water temperatures including short-term fluctuations in air and water temperatures; time of day and ambient light conditions; and the specific passage site location within a watershed. Changes in the timing (along with changes in species range and recruitment and habitat change due to sea-level rise) of Atlantic Coast migratory fish runs due to climate change have been identified in a number of locations (Huntington et al. 2003; Juanes et al. 2004; Fried and Schultz 2006; Ellis and Vokoun 2009; Wood and Austin 2009).

For purposes of this document, the federal agency team recommends that a NLF be designed to function in providing passable conditions over a range of flows from the 95% to 5% flow exceedance during the targeted species migratory run period or the collective run periods for multiple target species. The range of river flows used to inform the design of a fishway can be graphically represented by a flow duration curve (FDC). The FDC should be based on the historic probability of flows at the site, or scaled to the project site from an appropriately similar reference site. Active, continuously operated USGS stream gages typically provide the most reliable and complete record of flows for rivers and streams in the U.S. (More than 8,500 flow gages are currently operated by USGS, nationwide; <http://waterdata.usgs.gov/usa/nwis/rt>). To reasonably estimate future conditions, a sufficiently long period of record (POR) is required. In general, a POR of 10 to 30 years is recommended. Furthermore, the use of post-1970 flow data is preferred to account for documented increasing peak flows over time due to climatic change (See Collins 2009). Additional considerations that influence the length of the POR may include, but are not limited to, gauge data availability, alterations in upstream water management, and changing trends in watershed hydrology.

Body Morphology, Swimming and Leaping Capabilities and Behaviors

Diadromous fishes vary greatly in body shape and size and swimming and leaping capabilities. General body size in fish populations may be affected by genetics, environmental conditions and other factors. Historic fishery catch data indicate decreasing trends in average body size of anadromous fishes that have resulted from overharvesting and natural mortality factors (ASMFC 2012; Waldman 2014; Waldman et al. 2016). Fish body shape and anatomy are determinants of how a fish moves, functions, and adapts to its river environment. Fish body

size also affects swimming performance, and swimming ability is largely a function of fish biomechanics and hydrodynamics of its environment (Castro-Santos and Haro 2010). Larger fish have proportionally more propulsive area and a larger muscle mass, and are thus able to move at greater absolute speeds (i.e., the absolute distance through water covered over time). For example, a 10-cm long striped bass swimming at 5 body lengths per second will move through the water at 50 cm per second, while a 50 cm striped bass swimming at 5 body lengths per second will move through the water at 250 cm per second. Larger fish may also have a greater likelihood of injury from coming in contact with boulders or other structures. Fish age, physiological state, and environmental conditions such as water temperature, are additional factors influencing fish movement, behavior (e.g., propensity to pass in schools or groups), passage efficiency, and ultimately passage effectiveness.

In addition to swimming biomechanics, fish exhibit an equally important variety of behavioral responses to their physical and hydraulic environment such as motivation, attraction, avoidance, orientation, maneuvering, station-holding, depth selection, and schooling. In particular, schooling behavior occurs with some species and should be accommodated in fish passage design (e.g., passage opening dimensions and/or multiple openings within each boulder weir). Although basic behaviors of fish have been studied in both laboratory and field environments, only a modest number of behavioral studies have directly addressed fish passage. Most behavioral observations in reference to passageways have been a secondary outcome of passage evaluation studies, where study objectives or experimental designs were not focused on the evaluation of the causes of the behavioral responses.

Understanding the swimming capability of a target species is critical to designing fish passage sites. Swimming performance depends greatly on the relationship between swim speed and fatigue time. At slower speeds, fish can theoretically swim indefinitely using aerobic musculature. Once swim speed exceeds a certain threshold, fish begin to recruit different muscle fibers that function without using oxygen. This condition is noticeable by the onset of *burst-and-coast swimming* – a kinematic shift, whereby fish use both aerobic and anaerobic muscle fibers to power locomotion (Beamish 1978). Anaerobic muscle fibers can only perform for brief periods before running out of metabolic fuel; thus, high-speed swimming results in fatigue and is usually of very short duration. This physiological condition affects potential passage by a fish through high-velocity zones in rivers and fishways. In general, fish swim at speeds requiring anaerobic metabolism infrequently, given the energetic demands of this swimming mode.

Three operationally-defined swimming modes exist in fish: sustained, prolonged, and sprint speeds. Sustained swimming occurs at low or sustained speeds that are maintained for greater than 200 minutes (Beamish 1978). Prolonged swimming occurs at speeds that fish can maintain for 20 seconds to 200 minutes, and sprint swimming can only be maintained for periods of less than 20 seconds. Determining these swim modes and the critical swim speed – the threshold at which a fish changes from sustained to prolonged swim speeds (U_{crit}) is challenging. For many species, quantitative measures of these swimming modes are unknown, and only a few fish species have been comprehensively evaluated for all three modes.

Laboratory respirometer experiments are used to determine the thresholds for a species' swim speeds, but these tests tend to underestimate maximum swimming speed, and may therefore, be limited in accurately measuring burst-speed swimming. Determining burst swimming speeds is usually conducted in open channel flumes, but these experiments can also be biased by fish behavior, stress, or motivation (Webb 2006). Nonetheless, open channel flume studies usually provide better estimates of true swimming performance than results from studies of fish in respirometers, and are the preferred data source for determining fish swimming capabilities and for establishing the passage guidelines presented in this document (Castro-Santos and Haro 2006). Existing experimental swim data are also limited in terms of the size range of fish, species life history stage, and experimental water temperatures (Castro-Santos and Haro 2010). Swimming capabilities of fish may also be significantly influenced by turbulence, air entrainment, or other hydraulic/physical factors that influence swimming efficiency and fish motivation (Webb et al. 2010).

Leaping (or "jumping") is another component of swimming performance that must be considered in designing and assessing fish passage sites. Leaping height is positively correlated with swimming speed and water depth of the pool from which fish leap. Larger or deeper pools allow higher swimming velocities (i.e., a "running start") to be attained before leaping. Larger fish tend to have greater absolute leaping heights, but also require corresponding increased depths from which to leap. Leaping behavior can be initiated by the fall or plunging flow into a pool creating strong submerged water jets which serve as a stimulus and orientation cue for the direction and speed of an ensuing leap. While salmonids are known to leap during their upstream passage, many non-salmonid fish species are poor leapers or do not leap at all, being physically restricted by body morphology or maximum swimming speed, or more commonly, being behaviorally reluctant to do so. Leaping increases the potential risk of injury or stranding. Typically, leaping or sprint swimming behavior are expressed only when other behaviors are ineffective in passing a velocity or structural barrier. The design of fishways should present conditions that minimize leaping behaviors (USFWS 2016).

Federal Interagency Passage Design Guidelines

The following are key passage design guidelines that have been identified by the federal interagency team for application to passage of Atlantic Coast diadromous species, and for some species, more discrete guidelines according to life stage/body size categories for the species. These guidelines may be updated by the agencies as additional flume experiments, respirometer and other laboratory studies, and/or field research are completed and results become available that address the physiological and/or behavioral requirements, swimming and leaping capabilities, and passage efficiency of these diadromous fishes and/or other migratory species.

General Design Rationale

This section describes body morphologic dimensions which are determinants of passage, followed by a set of seven design guidelines for each species based on these fish biometrics,

plus a maximum velocity criterion based on each species swimming capability. Schematic illustrations are provided in **Figure 1** to accompany and help explain the descriptions of these passage guidelines. Some variables labeled in the graphics are not passage guidelines, but relate to the guidelines. Following the set of passage guidelines descriptions, we present **Table 2** which summarizes the passage guidelines for each of the 14 Atlantic Coast diadromous species, including two length categories for American eel and smaller-sized salmonids; and the basis for, and rationales used in developing this set of guidelines for each of the 14 target fish species.

Figure 1. Plan view (A), cross section (B), and profile (C) illustrations of physical features and nominal measures relating to passage design guidelines for a typical boulder step-pool type fishway.

Note: Schematic profile includes variables that relate to passage guidelines including: Q = flow, t_w = thickness of boulder weir, D = hydraulic drop, P_w = height of rock weir crest, H_w = head over the rock weir, H_g = gross head between headpond and tailwater water surface elevations, and L_t = total length of fishway.

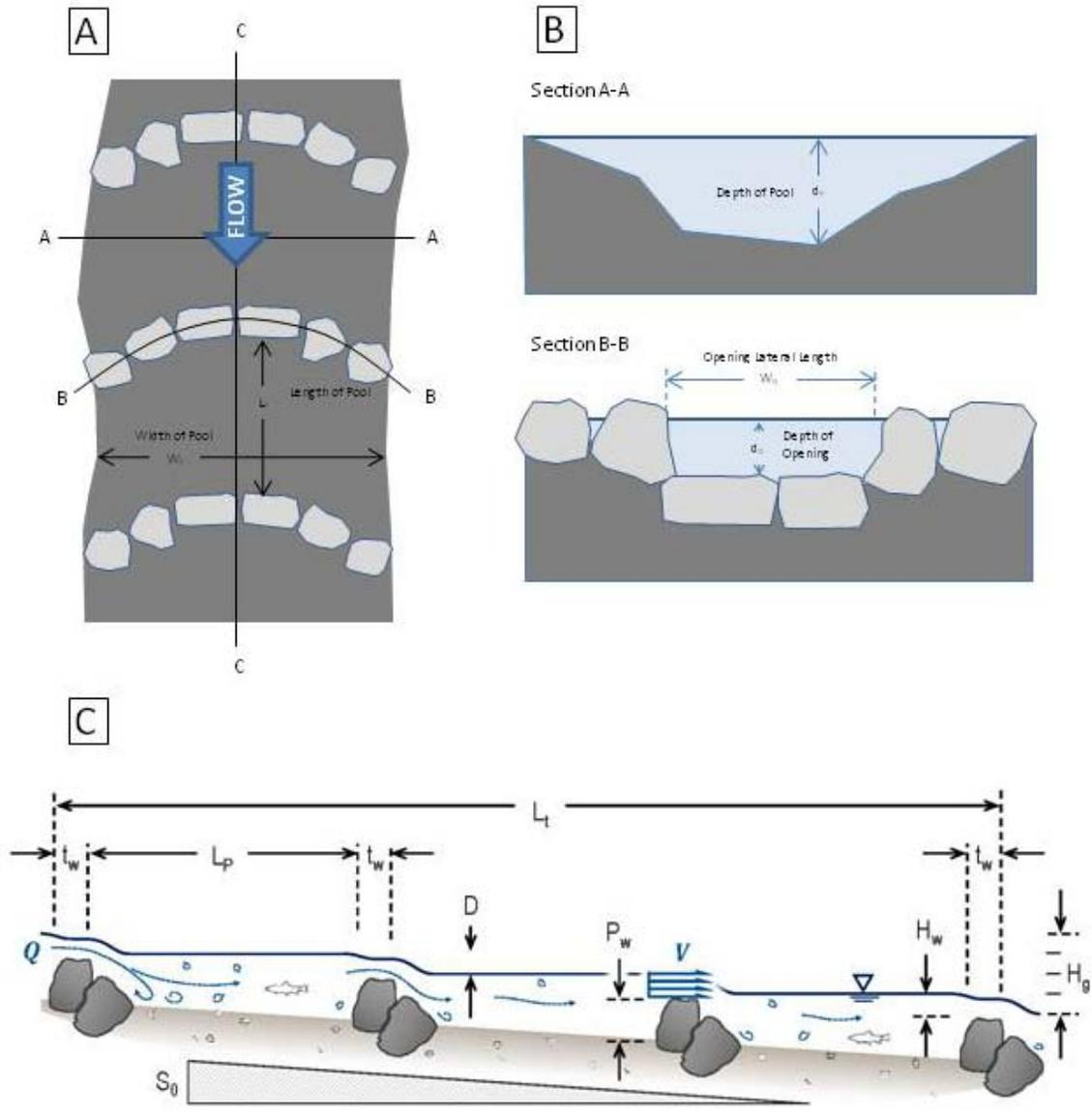

Fish Body Morphology (TL_{min} , TL_{max} , BD/TL Ratio): Maximum and minimum total lengths (TL_{max} and TL_{min} , respectively) and body depth (BD) to total length ratio (BD/TL) for each species were determined to the nearest cm from values published in the literature for diadromous fishes in the Atlantic Coast region. For species with limited or no published data available, unpublished data from recent field investigations were used (Refer to sources cited in species rationales section).

Pool Dimensions

Dimensions of a pool are based on the need to create full- or partial-width channels and pools or bypass channels with pools of sufficient size to serve as resting areas for the target fish species and provide for their protection from predators during passage. Larger fish or species that school in large numbers (hundreds to thousands) require wider, deeper, and longer pools.

The anticipated total run size of the target species and co-occurring species assemblages also need to be thoroughly considered in dimensioning pools.

As a guideline, pool dimensions should also be scaled relative to the size of the stream or river channel and existing pool conditions in nearby unaltered reach or reaches of the study river as a reference, and river flows for the specific design reach. This scaling guideline should be applied regardless of whether the design involves a full or partial width of the stream or river targeted for passage restoration, or is a nature-like bypass channel around a dam or other passage barrier that cannot be removed or modified. Each of the following dimensions should be considered in NLF design:

Minimum Pool Width (W_p): For full river-width structures, minimum pool width will vary depending on the size of the river or stream channel. For bypass channels, pool width will depend on maximum design width of the bypass, taking into account the proportion of the river flows used to design safe, timely and effective passage through the bypass during the full range of fish run flows at the subject river reach. To maximize energy dissipation, pool volume, and available resting areas, pool widths should generally be made as wide as practicable.

Minimum Pool Depth (d_p): In general, pools should be sufficiently deep to serve as resting areas, allow for maneuverability, accommodate deep-bodied and schooling species, and offer protection from terrestrial predators. For small streams (e.g., site with watershed area $<5 \text{ mi}^2$), the stream/river channel scaling guideline may be difficult to achieve, and the project design team should assess normal pool depth range in nearby reference reach(es) during the fish passage season. For downstream passage, a minimum depth of pools is needed to provide safe passage of fish and prevent injury or stranding of fish passing over a weir or through a weir opening, especially during low-flow outmigration conditions. Height of the fall as well as body mass of each species needs to be taken into account to minimize the potential for injury to out-migrating fish. For all species, a formula for minimum pool depth was derived which includes a minimum depth of 1 ft, plus 3 body depths, plus one additional body depth as a bottom buffer (to accommodate bottom unconformities and roughness); thus, $d_p = 1 \text{ ft} + 4 \text{ BD}$. Final values of the d_p guideline have been rounded up from the calculated value to the nearest 0.25 ft.

Minimum Pool Length (L_p): Pool length dimensions follow design guidelines similar to the pool widths, but also depths (i.e., maximize energy dissipation, pool volume and available resting areas; accommodate fish body size(s), run size(s), and resting and schooling behaviors). More importantly, pool length also determines overall slope of the fishway for a given drop per pool, so slope must be taken into account when determining minimum pool length (as well as the number of pools for a given design and overall drop). Refer to the Maximum Fishway Channel Slope (S_0) criterion which takes into account both pool length and drop-per-pool.

Minimum Weir Opening Width (W_N): The weir opening width (i.e., weir notch lateral length) relative to fish passage is based on providing a primary passage opening wide enough to accommodate fish body size and swimming mode and schools of upstream migrating target species adults. For sea lamprey and American eel (anguilliform swimmers), W_N equals 2 times the tailbeat amplitude (values from published literature) for the largest sized individual. For sturgeons, which possess a relatively wide body with broad pectoral fins, W_N equals 2 times the body width of the largest-sized individual, including maximum pectoral fin spread during passage. For all other target species, W_N equaled 2 times the maximum total body length. Final values of W_N were rounded up from the calculated value to the nearest 0.25 ft.

The opening width should also be designed for downstream migrating fish that may be oriented obliquely to the flow in a worst-case condition, to minimize potential body contact with (and subsequent injury) the weir-opening sidewall boulders. Wide weir openings also facilitate location of and attraction to the weir opening by fish in broader river reaches and passage sites by providing a flow jet that spans a larger proportion of the total pool width. Weirs will optimally have multiple passage openings, particularly on larger rivers, with varying invert elevations to function over a range of river flows during the passage season(s) and to benefit multiple species with varying swimming capabilities.

Conversely, the passage opening width needs to take into account the pool depth and hydraulics to accommodate the target species. For small streams with limited flows, the passage opening may need to be limited in width to maintain a minimum depth for passage due to very low flows over weirs, and in particular through a notch especially with lowest flows (e.g., flows <5 cfs) during the fish run period. Weirs should be properly designed such that modeled flows through a passage reach should result in submerged weirs or other grade control structures with passage openings, even during the lowest fish run flows. Such a design will result in streaming flow into a pool with water surface elevation at or above the upstream weir opening invert elevation, and preferably backwatering to the weir crest elevation.

Minimum Weir Opening Depth (d_N): Weir opening depths (i.e., weir notch) need to at least accommodate the full depth (vertical depth of body when swimming horizontally) of the body of the largest-sized target species, including extended dorsal and ventral fins to minimize potential for injury. We conservatively established d_N as 3 times the body depth of the largest-sized individual, rounded up to the nearest 0.25 ft. Minimum depths allow freedom of swimming movements and assurance that propulsion and maneuverability by the tail and fins will allow maximum generation of thrust and the ability of fish to maneuver. If limited river flows during the passage season(s) are not a concern, greater passage opening water depth is preferred at locations where schooling fish, like American shad, are passing simultaneously or passing fish are at high risk to predation. Sufficient water depths are also needed to create a low-velocity bottom zone to facilitate ascent by bottom-dwelling or smaller, weaker-swimming species.

The calculated low stream-flow for the target species run period is most critical to designing the weir opening dimensions and to ensure the minimum water depth guideline is attained. Thus,

depths of weirs, openings and other passageway features should be designed to accommodate minimum fish-run period flows and low-flow depths. This passage design need is most critical on small streams and watersheds where normal stream flow is limited (e.g., <20 cfs) and flow through a weir opening would be very limited (e.g., <2 cfs).

Maximum Weir Opening Water Velocity (V_{max}): The ability of fish to traverse zones of higher water velocity, particularly through passage openings, is dependent on motivation, physiological capability (sprint swimming speed), and size range of the target species, and the overall distance that the fish must swim through a high-velocity passage zone. For most weir openings in typical fishway designs, the distances and durations that fish must swim to make upstream progress is relatively short (i.e., tens of feet), so fish may be able to swim over weirs or through these openings at prolonged or brief sprint speeds resulting in minimal fatigue. The probability of fish passing upstream through velocity barriers at prolonged or sprint speeds can be calculated for some species based on known high-speed swimming performance or empirical high-speed swimming model data, particularly the critical swim speed for a species (e.g., Weaver 1965, McAuley 1996, Haro et al. 2004). Sprint swimming data, if available, are usually the best data to use to infer maximum weir opening water velocity. However, sprint swimming research has not been conducted and/or sprint swimming curves have not been developed for most Atlantic Coast diadromous fish species, in which case, alternative methods for determining maximum weir opening velocity were used for developing this guideline.

The following rationale was used to determine V_{max} for each species:

1. When sprint swimming data are available, then U_{max} = the sprint swimming speed sustained for 60 sec, for fish of minimum size (TL_{min}).
2. When no sprint swimming data are available, but critical swimming speed (U_{crit}) values have been determined (i.e., from respirometer studies), then U_{max} = 2 times U_{crit} for fish of minimum size (TL_{min}).
3. When no swimming data are available, U_{max} is calculated for a nominal value of 5 BL/sec for subcarangiform swimmers or 3 BL/sec for anguilliform swimmers, for fish of minimum size (TL_{min}).
4. The initial value of U_{max} was adjusted (if necessary) by assessing calculated U_{max} values within the context of other direct fish swimming observations of each species and known velocity barriers (if available; i.e., observed ability to pass a velocity barrier with known water velocity, or best professional judgment, based on experience).
5. V_{max} = U_{max} , rounded down to the nearest 0.25 ft/sec.

The V_{max} applied in each project should be the value associated with the weakest swimming target species. The V_{max} values presented herein for each species are specifically provided for the targeted species expecting to pass over a weir, through a weir opening or other short-distance high velocity zone and into an effective resting area. A V_{max} value should not be misapplied as the guideline for the overall design or diagnostic evaluation of an entire fishway or fish passage reach, where passage length and time of passage would exceed the capability of the target species in sprint swimming mode to pass the site without available resting pools or

sites. Such an example may include a rock ramp nature-like fishway constructed at too steep a slope for the target species, and which lacks resting pools, large boulders, or other features providing adequate resting areas.

Maximum Fishway Channel Slope (S_0): The channel slope, S_0 , influences energy loss and water velocity over weirs, through weir notches, in pools, and around other in-stream features. In turn, velocity and energy dissipation influence fish behavior and passage efficiency. The friction slope, S_f , is the rate at which this energy is lost along the channel. In prismatic-shaped channels, uniform flow (i.e., flow that is unchanging in the longitudinal direction) occurs when $S_0 = S_f$. In step-pool fishway structures, the average friction slope is equal to the ratio of hydraulic drop-per-pool, D , to pool length plus weir thickness, $L_p + t_w$ (Figure 1). Thus, quasi-uniform or “uniform-in-the-mean” flow is achieved in step-pool fishways when S_0 and the average S_f are equal over the length of the fishway. In most cases, step-pool fishways are designed for this quasi-uniform condition to limit longitudinal flow development (e.g., accelerating flow) and ensure predictable hydraulic conditions in each pool and over each weir.

Quasi-uniform flow establishes a relationship between S_0 and S_f in step-pool structures; however, an additional constraint on S_0 is necessary to safeguard against unacceptably steep fishway designs. Both the pool length and drop-per-pool criteria are based on a species’ need for adequate resting space and swimming capability, respectively. Fishway channel slopes based solely on quasi-uniform flow and a friction slope established by the recommended maximum D and minimum L_p may still result in excessive energy dissipation, propagation of velocity from pool to pool, and/or other undesirable conditions. Therefore, a maximum fishway channel slope, S_0 , is also recommended. These channel slopes presented herein (Table 2) are conservative estimates based on natural river gradients and sites known to be passable or populated by the target species.

The reader is cautioned that these slope relationships and associated pool and hydraulic drop criteria create an over-determined system (i.e., more equations than unknowns). To avoid conflicting slope constraints, the following procedure is recommended:

1. Based on a species’ V_{max} (Refer to Table 2, below), calculate an appropriate D ;
2. Based on D and L_p (Table 2), estimate the friction slope, S_f ;
3. If $S_f \leq$ channel slope S_0 (Table 2), then set $S_0 = S_f$ and proceed;
If $S_f > S_0$, then lengthen L_p or add pools to the design to reduce D (while ensuring minimum depth of flow criterion is also met) until $S_f \leq S_0$, and proceed.

Consider the following example for the passage of alewife over a step-pool structure: For this target species, a V_{max} of 6 ft/sec is recommended (Table 2). To provide structural stability, a 3-ft wide rock weir is selected. Using this V_{max} and t_w , a hydraulic analysis results in a maximum drop-per-pool of $D = 1.25$ ft. For alewife as the target species, a minimum pool length of $L_p = 10$ ft is recommended (Table 2). This results in a friction slope, $S_f = 0.092$ which exceeds the specified maximum pool slope of $S_0 = 0.05$ or 1:20 (Table 2). Accordingly, the geometry needs

to be revised to ensure the maximum channel slope criterion is met. The L_p must be increased, D must be decreased, or both until $S_f \leq S_0$.

In general, consistent pool geometry is preferred, but may not be feasible for some passage sites. When site constraints necessitate pools of varying geometry, the procedure above should be applied, iteratively, to each pool-and-weir combination to ensure S_0 , S_f , and the other passage criteria are met.

The above methodology integrates species-specific biological criteria from Table 2 and engineering hydraulics. However, it is important to note that fishway geometry is also influenced by other site conditions and target fish species behavioral factors. Additional considerations include substrate stability, channel morphology, immovable boulders/ledge and other natural features that may further constrain the slope of the fishway. Excessively long pool length, which may otherwise meet slope criteria, may decrease motivation of a target species to pass, thus, compromising passage efficiency. As fish passage planning progresses from conceptual to final design, it is critical to verify these parameters with each design modification to ensure that criteria are still met for the weakest target species and over the greatest possible range of hydrologic conditions at the project site.

Other Design Considerations: For moderate and large-sized rivers, multiple weir openings should be provided for safe passage by multiple target species and schools of a species that behaviorally pass in groups (e.g., American shad). The design should consider the diversity of the fish community present in the stream or river. Large rivers with greater spatial habitat diversity typically support a greater number of both resident and anadromous species, with large numbers of fishes seasonally passing upriver often during coincidental, overlapping spawning run periods. A diverse fish assemblage and large numbers of fish passing necessitate multiple passage openings, and benefitting from varying invert elevations and locations along the weir to account for changes in river flow, especially in larger rivers with a diverse fish assemblage and/or widely varying fish run flow range. Weaker-swimming species will use passage openings closer to the river edge and inside river bends where lower flow velocities occur. Weak-swimming species (e.g., minnows, darters) and some species life-stages (e.g., American eel elvers and yellow-phase juveniles) seek out low-velocity, near-bottom conditions not only for passage sites but often as habitat (Aadland 1993).

Regarding passage at weirs, fish will preferentially pass through weir openings, rather than over weir crests. Fish preferentially use streaming flow through openings, as opposed to plunging flows passing over weirs and into resting pools which are often impassible for species with limited leaping capabilities. Although an in-line configuration of weir openings is preferred, primary openings along multiple weirs can be off-set in alignment to prevent propagation of increasing flow velocities through successive weirs or other grade control structures.

Channel size and flow (e.g., bypass channels) should be referenced to both river size and projected run size of the target fish species or fish community assemblage. For example, nature-like bypass fishways sited on large rivers would need to be appropriately sized for flow

and run-size capacity. Fishways which are expected to support large runs of target species should include longer and deeper pools to provide sufficient resting areas to accommodate large numbers of fish during peak passage periods.

Figure 2 presents examples of photographed NLF sites constructed in the Northeast region targeted for passage by Atlantic coast diadromous fish species.

Table 2. Summary of design guidelines for NLFs and related to swimming capabilities and safe, timely and efficient passage for Atlantic Coast diadromous fish species. Note: units are expressed in both metric (cm) and English units (feet or feet/sec). See text for informational sources.

Species	Minimum TL (cm)	Maximum TL (cm)	Body Depth/ TL Ratio	Maximum Body Depth (cm)	Minimum Pool/Channel Width (ft)	Minimum Pool/Channel Depth (ft)	Minimum Pool/Channel Length (ft)	Minimum Weir Opening Width (ft)	Minimum Weir Opening Depth (ft)	Maximum Weir Opening Water Velocity (ft/sec)	Maximum Fishway Channel Slope
	TL _{min}	TL _{max}	BD/TL	BD _{max}	W _p	d _p	L _p	W _N	d _N	V _{max}	S ₀
Sea Lamprey	60	86	0.072	6.2	10.0	2.00	20.0	0.75	0.75	6.00	1:30
Shortnose Sturgeon	52	143	0.148	21.2	30.0	4.00	30.0	2.75	2.25	5.00	1:50
Atlantic Sturgeon	88	300	0.150	45.0	50.0	7.00	75.0	5.50	4.50	8.50	1:50
American Eel ≤ 15 cm TL	5	15	0.068	1.0	3.0	1.25	5.0	0.25	0.25	0.75	1:20
American Eel >15 cm TL	15	116	0.068	7.9	6.0	2.00	10.0	0.75	1.00	1.00	1:20
Blueback Herring	20	31	0.252	7.8	5.0	2.00	10.0	2.25	1.00	6.00	1:20
Alewife	22	38	0.233	8.9	5.0	2.25	10.0	2.50	1.00	6.00	1:20
Hickory Shad	28	60	0.221	13.3	20.0	2.75	40.0	4.00	1.50	4.50	1:30
American Shad	36	76	0.292	22.2	20.0	4.00	30.0	5.00	2.25	8.25	1:30
Gizzard Shad	25	50	0.323	16.2	20.0	3.25	40.0	3.50	1.75	4.00	1:30
Rainbow Smelt	12	28	0.129	3.6	5.0	1.50	10.0	1.00	0.50	3.25	1:30
Atlantic Salmon	70	95	0.215	20.4	20.0	3.75	40.0	6.25	2.25	13.75	1:20
Sea Run Brook Trout	10	45	0.255	11.5	5.0	2.50	10.0	1.50	1.25	3.25	1:20
Juvenile Salmonid ≤ 20 cm TL	5	20	0.250	5.0	5.0	1.75	10.0	1.25	0.50	2.25	1:20
Atlantic Tomcod	15	30	0.202	6.1	5.0	2.00	10.0	2.00	0.75	0.75	1:30
Striped Bass	40	140	0.225	31.5	20.0	5.25	30.0	9.25	3.25	5.25	1:30

Figure 2. Captioned photographs of nature-like fishways (NLFs) in the Northeast targeting passage of Atlantic coast diadromous fishes (Photo sources: J. Turek, M. Bernier)



Saw Mill Park step-pool fishway,
Acushnet River, Acushnet, MA



Fields Pond step-pool fishway,
Sedgeunkedunk Stream, Orrington, ME



Kenyon Mill step-pool fishway,
Pawcatuck River, Richmond, RI



Homestead dam removal and NLF cross-vanes,
Ashuelot River, West Swanzey, NH



Water Street tidal rock ramp,
Town Brook, Plymouth, MA



Lower Shannock Falls NLF weirs,
Pawcatuck River, Richmond, RI

Species-Specific Rationales

The following passage guidelines rationales for each species are based upon best professional judgment, unless otherwise noted by referenced published literature or other source(s). We applied our experiences with laboratory flume experiments and field observations, and queried other state and federal agency experts in fishery biology and/or fishway engineering design. We note that there is a general paucity of experimental research available, and substantial additional species information is required to verify or refine these guidelines.

Sea Lamprey

$TL_{min} = 60$ cm (Collette and Klein-MacPhee 2002)

$TL_{max} = 86$ cm (USFWS Connecticut River Coordinator's Office, unpub. data)

Body Depth/TL Ratio = 0.072 (A. Haro, USGS; unpub. data)

Minimum Pool/Channel Width: 10.0 ft

The guideline is based on creation of pools large enough to serve as resting areas and protection from terrestrial predators. Lamprey tends to rest in pool environments more so than other species, and often aggregate in large numbers while resting. Larger run sizes (hundreds to thousands) will require resting pools wider than this minimum dimension.

Minimum Pool/Channel Depth: 2.0 ft

The guideline is based on creation of pools large enough to serve as resting areas and protection from terrestrial predators. Minimum pool depth was calculated using the formula $1 \text{ ft} + 4BD_{max}$: $d_p = 1 \text{ ft} + (4 * (86 \text{ cm} * 0.072) * 0.0328) = 1.8 \text{ ft}$. This value was rounded up to $d_p = 2.0 \text{ ft}$. Lamprey tends to rest in pool environments more so than other species, and often aggregate in large numbers while resting. Larger run sizes (hundreds to thousands) will require pools deeper than this minimum dimension.

Minimum Pool/Channel Length: 20.0 ft

The guideline is based on creation of pools large enough to accommodate lamprey body size, run size, and resting and schooling behavior, as well as meeting minimum weir velocity and maximum energy dissipation and slope guidelines. Lampreys tend to rest in pool environments more than other species, and often aggregate in numbers while resting. Larger run sizes (hundreds to thousands) will require pools longer than this minimum dimension.

Minimum Weir Opening Width: 0.75 ft

The minimum opening width guideline is based on a dimension wide enough to accommodate the two times the tailbeat amplitude of the maximum total length (TL) of adult lamprey. Because adult sea lamprey die after spawning, there is no design consideration for downstream passage. Tailbeat amplitude for sea lamprey has been measured as 10% of total length (Bainbridge 1958). Therefore $WN = 86 \text{ cm} * 2 * 0.1 = 17.2 \text{ cm} = 0.56 \text{ ft}$. This value was rounded up to $WN = 0.75 \text{ ft}$.

Minimum Weir Opening Depth: 0.75 ft

The guideline is based on provision of sufficient water depth over the weir to enable protection from terrestrial predators, lamprey maneuvering in low flows, and use of lower velocity zone in high flows; equivalent to 3 times $BD_{max} = 3 * 6.15 \text{ cm} = 18.5 \text{ cm} = 0.61 \text{ ft}$. This value was rounded up to $d_N = 0.75 \text{ ft}$.

Maximum Weir Opening Water Velocity: 6.0 ft/sec

The guideline takes into consideration laboratory sprint swimming studies in an open channel flume (McAuley 1996): approximately 1.0 m/sec swimming speed for a maximum of 60 sec duration for adult lamprey ($TL_{min} = 60 \text{ cm}$; $U=2 \text{ BL/sec}$). Therefore $U_{max} = (2 * 60 \text{ cm}) = 120 \text{ cm/sec} = 3.94 \text{ ft/sec}$. However, adult sea lampreys are known to have the capability to free-swim ascend surface weirs in technical fishways at velocities of 8.0 ft/sec (Haro and Kynard 1997). Since laboratory studies and field observations suggest strong but varying swimming capabilities, V_{max} was conservatively established at 6.0 ft/sec.

Maximum Fishway/Channel Slope: 1:30

This nominal slope guideline approximates the maximum slope at natural river sites known to be passable by sea lamprey, or is a conservative estimate of maximum slope based on known sea lamprey swimming behavior and river hydro-geomorphologies in which sea lamprey occurs.

Shortnose Sturgeon

$TL_{min} = 52 \text{ cm}$ (Collette and Klein-MacPhee 2002)

$TL_{max} = 143 \text{ cm}$ (Dadswell 1979)

Body Depth/TL Ratio = 0.148 (M. Kieffer, USGS; unpub. data)

Minimum Pool/Channel Width: 30.0 ft

The guideline is based on pools large enough to serve as sturgeon resting areas and protection from terrestrial predators. Sturgeons typically require larger than average pools, especially if multiple sturgeon are migrating simultaneously through a passageway. While data are lacking for shortnose sturgeon, lake sturgeon are known to use and pass nature-like fishways in groups (L. Aadland, pers. commun.).

Minimum Pool/Channel Depth: 4.0 ft

The guideline is based on creation of pools large enough to serve as resting areas and protection from terrestrial predators. Minimum pool depth was calculated using the formula $1 \text{ ft} + 4BD_{max}$: $d_p = 1 \text{ ft} + (4 * (143 \text{ cm} * 0.148) * 0.0328) = 3.8 \text{ ft}$. This value was rounded up to $d_p = 4.0 \text{ ft}$. Sturgeons typically require larger than average-sized pools, especially if multiple sturgeon are migrating simultaneously through a passageway.

Minimum Pool/Channel Length: 30.0 ft

The guideline is based on pools large enough to accommodate sturgeon body size, run size, and resting and schooling behavior, as well as meeting minimum weir velocity and maximum energy

dissipation and slope guidelines. Shortnose sturgeon may aggregate in large numbers while resting in pools. Larger run sizes (hundreds or greater) will require pools longer than this minimum dimension.

Minimum Weir Opening Width: 2.75 ft

The minimum opening width guideline is based on a dimension wide enough to accommodate two times the total body width (including pectoral fin spread) of the maximum total length (TL) of adult shortnose sturgeon. Data are lacking for total body span (including pectoral fins) for shortnose sturgeon, but have been estimated as 27% of TL in lake sturgeon (L. Aadland, Minnesota Department of Natural Resources, pers. comm.). Therefore, $W_N = 143 \text{ cm} * 2 * 0.27 = 77.2 \text{ cm} = 2.53 \text{ ft}$. This value was rounded up to $W_N = 2.75 \text{ ft}$.

Minimum Weir Opening Depth: 2.25 ft

The guideline is based on provision of sufficient water depth over the weir to enable protection from terrestrial predators, sturgeon maneuvering in low flows, and use of lower velocity zone in high flows; equivalent to 3 times $BD_{max} = 3 * 21.19 \text{ cm} = 63.6 \text{ cm} = 2.09 \text{ ft}$. This value was rounded up to $d_N = 2.25 \text{ ft}$.

Maximum Weir Opening Water Velocity: 5.0 ft/sec

No sprint swimming data are available for adult shortnose sturgeon; U_{crit} for adult shortnose sturgeon is unknown. Based on maximum $U = 3 \text{ BL/sec}$ for anguilliform swimmers and affording passage of smallest sized adults, $U_{max} = 3 * 52 \text{ cm} = 156 \text{ cm/sec} = 5.12 \text{ ft/sec}$. This value was rounded down to $V_{max} = 5.0 \text{ ft/sec}$.

Maximum Fishway/Channel Slope: 1:50

This nominal slope guideline approximates the maximum slope at natural river sites known to be passable by shortnose sturgeon, or is a conservative estimate of maximum slope based on known shortnose sturgeon swimming behavior and river hydro-geomorphologies in which this sturgeon species occurs.

Atlantic Sturgeon

$TL_{min} = 88 \text{ cm}$ (M. Kieffer, USGS, unpub.data)

$TL_{max} = 300 \text{ cm}$ (M. Kieffer, USGS, unpub.data)

Body Depth/TL Ratio = 0.150 (M. Kieffer, USGS, unpub.data)

Minimum Pool/Channel Width: 50.0 ft

The guideline is based on creation of pools large enough to serve as resting areas and protection from terrestrial predators. Sturgeons typically require larger than average pools, especially if multiple sturgeon are migrating simultaneously through a passageway.

Minimum Pool/Channel Depth: 7.0 ft

The guideline is based on creation of pools large enough to serve as resting areas and protection from terrestrial predators. Minimum pool depth was calculated using the formula 1

$ft + 4BD_{max}: d_p = 1 \text{ ft} + (4 * (300 \text{ cm} * 0.150) * 0.0328) = 6.9 \text{ ft}$. This value was rounded up to $d_p = 7.0 \text{ ft}$. Sturgeons typically require larger than average-sized pools, especially if multiple sturgeon are migrating simultaneously through a passageway.

Minimum Pool/Channel Length: 75.0 ft

The guideline is based on creation of pools large enough to accommodate sturgeon body size, run size, and resting and schooling behavior, as well as meeting minimum weir velocity and maximum energy dissipation and slope guidelines. Atlantic sturgeon may aggregate in large numbers while resting in pools. Larger run sizes (hundreds or greater) will require pools longer than this minimum dimension.

Minimum Weir Opening Width: 5.50 ft

The minimum opening width guideline is based on a dimension wide enough to accommodate two times the total body width (including pectoral fin spread) of the maximum total length (TL) of adult Atlantic sturgeon. Data are lacking for total body span (including pectoral fins) for Atlantic sturgeon, but have been estimated as 27% of TL in lake sturgeon (L. Aadland, Minnesota Department of Natural Resources, pers. comm.). Therefore, $W_N = 300 \text{ cm} * 2 * 0.27 = 162 \text{ cm} = 5.31 \text{ ft}$. This value was rounded up to $W_N = 5.50 \text{ ft}$.

Minimum Weir Opening Depth: 4.5 ft

The guideline is based on provision of sufficient water depth over the weir to enable protection from terrestrial predators, sturgeon maneuvering in low flows, and use of lower velocity zone in high flows; equivalent to 3 times $BD_{max} = 3 * 45.00 \text{ cm} = 135.0 \text{ cm} = 4.43 \text{ ft}$. This value was rounded up to $d_N = 4.5 \text{ ft}$.

Maximum Weir Opening Water Velocity: 8.5 ft/sec

No sprint swimming data are available for adult Atlantic sturgeon; U_{crit} for adult Atlantic sturgeon is unknown. Based on $U=3 \text{ BL/sec}$ for anguilliform swimmers; $U_{max} = (3 * 88 \text{ cm}) = 264 \text{ cm/sec} = 8.66 \text{ ft/sec}$. This value was rounded down to $V_{max} = 8.5 \text{ ft/sec}$.

Maximum Fishway/Channel Slope: 1:50

This nominal slope guideline approximates the maximum slope at natural river sites known to be passable by Atlantic sturgeon, or is a conservative estimate of maximum slope based on known Atlantic sturgeon swimming behavior and river hydro-geomorphologies in which sturgeon occur.

***American Eel* $\leq 15 \text{ cm}$ ($\leq 6 \text{ inch}$) TL**

$TL_{min} = 5 \text{ cm}$ (Haro and Krueger 1991)

$TL_{max} = 15 \text{ cm}$ (upper limit of specified range)

Body Depth/TL Ratio = 0.068 (A. Haro, USGS, unpub.data)

Small ($\leq 15 \text{ cm TL}$) American eels (elvers and small juveniles) are usually upstream migrants, passing through low-velocity flows along river edges and through openings, voids, and crevices

in natural and man-made barriers and other riverside structures. Small eels can also climb wetted surfaces for significant distances, aided by water-surface tension. Small eels therefore may only require small openings or passageways, preferably along low-velocity river edges, where they commonly congregate. Design guidelines were developed for two eel size classes since eels continue upstream migration for multiple years and eels may not ascend to distant upstream sites during elver/small juvenile eel stage. These upstream sites are more likely to only pass larger, older, yellow eels; guidelines for elvers and small eels would therefore not apply. Size distribution of eels should be assessed at sites considered for nature-like fishway planning before guidelines for upstream eel passage are applied in design. Guidelines for this size range do not take into account downstream passage; see next Section (American Eel > 15 cm TL) for downstream passage guidelines relevant to adult (“silver” phase) or larger, downstream-moving juvenile (“yellow phase”) American eel.

Minimum Pool/Channel Width: 3.0 ft

The guideline is based on creation of pools large enough to serve as resting areas and protection from terrestrial predators. American eels tend to rest in pool environments more so than other species, and young eels often aggregate in large numbers while resting, particularly within the substrate. Larger run sizes (hundreds to thousands) will require pools wider than this minimum dimension.

Minimum Pool/Channel Depth: 1.25 ft

The guideline is based on creation of pools large enough to serve as resting areas and protection from terrestrial predators. Minimum pool depth was calculated using the formula $1 \text{ ft} + 4BD_{\text{max}}$: $d_p = 1 \text{ ft} + (4 * (15 \text{ cm} * 0.068) * 0.0328) = 1.1 \text{ ft}$. This value was rounded up to $d_p = 1.25 \text{ ft}$. American eel tend to rest in pool environments more so than other species, and young eels often aggregate in large numbers while resting, particularly within the substrate. Larger run sizes (hundreds to thousands) will require pools deeper than this minimum dimension.

Minimum Pool/Channel Length: 5.0 ft

The guideline is based on creation of pools large enough to accommodate eel body size, run size, and resting and schooling behavior, as well as meeting minimum weir velocity and maximum energy dissipation and slope guidelines. American eel tend to rest in pool environments more so than other species, and young eels often aggregate in large numbers while resting in pools. Larger run sizes (thousands or greater) will require pools longer than this minimum dimension.

Minimum Weir Opening Width: 0.25 ft

The minimum opening width guideline is based on a dimension wide enough to accommodate the two times the tailbeat amplitude of the maximum total length (TL) of small American eels. Tailbeat amplitude for American eels has been measured as 8% of total length (Gillis 1998). Therefore $W_N = 15 \text{ cm} * 2 * 0.08 = 2.4 \text{ cm} = 0.08 \text{ ft}$. This value was rounded up to $W_N = 0.25 \text{ ft}$. However, as adults, eels may migrate downstream through weir openings, so a larger weir opening width may be required.

Minimum Weir Opening Depth: 0.25 ft

The guideline is based on provision of sufficient water depth over the weir to enable protection from terrestrial predators, maneuvering in low flows, and use of lower velocity zone in high flows; equivalent to 3 times $BD_{max} = 3 * 1.02 \text{ cm} = 3.1 \text{ cm} = 0.10 \text{ ft}$). This value was rounded up to $d_N = 0.25 \text{ ft}$. However, as adults, eels may migrate downstream through weir openings, so a larger opening may be required (See *American Eel > 15 cm TL; Minimum Weir Opening Depth*).

Maximum Weir Opening Water Velocity: 0.75 ft/sec

The guideline is based on laboratory sprint swimming studies (McCleave 1980): $U = 4.6 \text{ BL/sec}$ swimming speed for maximum 60 sec duration for 5 cm TL elvers in an open channel test flume. Therefore, $U_{max} = 4.6 * 5 \text{ cm} = 23 \text{ cm/sec} = 0.75 \text{ ft/sec}$. V_{max} was established at 0.75 ft/sec.

Maximum Fishway/Channel Slope: 1:20

This nominal slope guideline approximates the maximum slope at natural river sites known to be passable by juvenile American eel, or is a conservative estimate of maximum slope based on known eel swimming behavior and river hydro-geomorphologies in which eel occur.

American Eel > 15 cm (>6 inch) TL

$TL_{min} = 15 \text{ cm}$ (lower limit of specified range)

$TL_{max} = 116 \text{ cm}$ (Tremblay 2009)

Body Depth/TL Ratio = 0.068 (A. Haro, USGS, unpub.data)

Minimum Pool/Channel Width: 6.0 ft

The guideline is based on creation of pools large enough to serve as resting areas and protection from terrestrial predators. American eels tend to rest in pool environments more so than other species, and often aggregate in large numbers while resting, particularly within the substrate. Larger run sizes (hundreds to thousands) will require pools wider than this minimum dimension.

Minimum Pool/Channel Depth: 2.0 ft

The guideline is based on creation of pools large enough to serve as resting areas and protection from terrestrial predators. Minimum pool depth was calculated using the formula $1 \text{ ft} + 4BD_{max}$: $d_p = 1 \text{ ft} + (4 * (116 \text{ cm} * 0.068) * 0.0328) = 2.0 \text{ ft}$. American eels tend to rest in pool environments more so than other species, and often aggregate in large numbers while resting, particularly within the substrate. Larger run sizes (hundreds to thousands) will require pools deeper than this minimum dimension.

Minimum Pool/Channel Length: 10.0 ft

The guideline is based on creation of pools large enough to accommodate fish size, run size, and resting and schooling behavior, as well as meeting minimum weir velocity and maximum energy dissipation and slope guidelines. American eel tend to rest in pool environments more so than other species, and often aggregate in large numbers while resting in pools. Larger run sizes (thousands or greater) will require pools longer than this minimum dimension.

Minimum Weir Opening Width: 0.75 ft

The minimum opening width guideline is based on a dimension wide enough to accommodate the two times the tailbeat amplitude of the maximum total length (TL) of larger American eels. Tailbeat amplitude for American eels has been measured as 8% of total length (Gillis 1998). Therefore, $W_N = 116 \text{ cm} * 2 * 0.08 = 18.6 \text{ cm} = 0.61 \text{ ft}$. This value was rounded up to $W_N = 0.75 \text{ ft}$. However, as adults, eels may migrate downstream through weir openings, so a larger weir opening width may be required.

Minimum Weir Opening Depth: 1.0 ft

The guideline is based on provision of sufficient water depth over the weir to enable protection from terrestrial predators, maneuvering in low flows, and use of lower velocity zone in high flows; equivalent to 3 times $BD_{max} = 3 * 7.9 \text{ cm} = 23.4 \text{ cm} = 0.76 \text{ ft}$. This value was rounded up to $d_N = 1.0 \text{ ft}$.

Maximum Weir Opening Water Velocity: 1.0 ft/sec

The guideline is based on mean $U_{crit} = 0.43 \text{ m/s}$ for eels of mean length 44 cm eel; $U = 0.97 \text{ BL/sec}$ in respirometer experiments (Quintella et al. 2010). Therefore, $U_{max} = 2 * 0.97 * 15 \text{ cm} = 29.1 \text{ cm/sec} = 0.95 \text{ ft/sec}$. This value was rounded up to $V_{max} = 1.0 \text{ ft/sec}$.

Maximum Fishway/Channel Slope: 1:20

This nominal slope guideline approximates the maximum slope at natural river sites known to be passable by American eel, although juvenile eels are capable of ascending substrates with steeper slopes having roughened surfaces and/or interstitial spaces within boulders, cobbles or other structures.

Blueback Herring

$TL_{min} = 20 \text{ cm}$ (Collette and Klein-MacPhee 2002)

$TL_{max} = 31 \text{ cm}$ (S. Turner, NMFS, unpub. data)

Body Depth/TL Ratio = 0.252 (A. Haro, USGS, unpub. data)

Minimum Pool/Channel Width: 5.0 ft

The guideline is based on pools large enough to serve as resting areas and protection of adults from terrestrial predators. Blueback herring is a schooling species and often aggregates in large numbers while resting in pools. Larger run sizes (hundreds to thousands or more) will require pools wider than this minimum dimension.

Minimum Pool/Channel Depth: 2.0 ft

The guideline is based on pools large enough to serve as resting areas and protection of adults from terrestrial predators. Minimum pool depth was calculated using the formula $1 \text{ ft} + 4BD_{max}$: $d_p = 1 \text{ ft} + (4 * (31 \text{ cm} * 0.252) * 0.0328) = 2.0 \text{ ft}$. Blueback herring is a schooling species and often aggregates in large numbers while resting in pools. Larger run sizes (thousands or more) will require pools deeper than this minimum dimension. This depth guideline may not be

feasible on very small-sized, first- and second-order streams with small watersheds (e.g., <5 mi²), limited stream flows, and smaller run sizes (hundreds of fish or less).

Minimum Pool/Channel Length: 10.0 ft

The guideline is based on pools large enough to accommodate herring body size, run size, and resting and schooling behavior, as well as meeting minimum weir velocity and maximum energy dissipation and slope guidelines. Blueback herring is a schooling species and often aggregates in large numbers while resting in pools. Larger run sizes (thousands or greater) will require pools longer than this minimum dimension.

Minimum Weir Opening Width: 2.25 ft

The guideline is based on a weir dimension wide enough to accommodate downstream movement of adult blueback herring oriented in “worst case” perpendicular orientation to the flow, equivalent to 2 times TL_{max} or 2 * 31 cm = 62 cm = 2.03 ft. This value was rounded up to W_N = 2.25 ft. In the case of larger populations (thousands or greater), entrance dimensions should be greater than 2.25 ft, or multiple openings of this minimal dimension should be constructed in weirs to accommodate multiple groups of fish simultaneously passing through the weir opening(s).

Minimum Weir Opening Depth: 1.0 ft

The guideline is based on provision of sufficient water depth over the weir to enable protection from terrestrial predators, herring maneuvering in low flows, and use of lower velocity zone in high flows; equivalent to 3 times BD_{max} = 3 * 7.81 cm = 23.4 cm = 0.77 ft. This value was rounded up to d_N = 1.0 ft.

Maximum Weir Opening Water Velocity: 6.0 ft/sec

The guideline is based on laboratory sprint swimming studies in an open channel flume (Haro et al. 2004, Castro-Santos 2005): U=6 BL/sec swimming speed for a maximum 60 sec. Therefore U_{max} = (6 * 20 cm) = 120 cm/sec = 3.94 ft/sec. However, adult blueback herring are known to ascend surface weirs, natural ledge drops, and technical fishways at velocities of 8.0 ft/sec or higher (Reback et al. 2004). To address the varying data currently available, V_{max} was established at 6.0 ft/sec.

Maximum Fishway/Channel Slope: 1:20

This nominal slope guideline approximates the maximum slope at natural river sites known to be passable by blueback herring (Franklin et al. 2012), or is a conservative estimate of maximum slope based on known blueback herring swimming behavior and river hydro-geomorphologies in which blueback herring occur.

Alewife

TL_{min} = 22 cm (Collette and Klein-MacPhee 2002)

TL_{max} = 38 cm (Collette and Klein-MacPhee 2002)

Body Depth/TL Ratio = 0.233 (G. Wippelhauser, Maine Div. Marine Fisheries, unpub. data)

Minimum Pool/Channel Width: 5.0 ft

The guideline is based on creation of pools large enough to serve as resting areas and protection from terrestrial predators. Alewife is a schooling species and often aggregates in large numbers while resting in pools. Larger run sizes (hundreds to thousands) will require pools wider than this minimum dimension.

Minimum Pool/Channel Depth: 2.25 ft

The guideline is based on creation of pools large enough to serve as resting areas and protection from terrestrial predators. Minimum pool depth was calculated using the formula $1 \text{ ft} + 4BD_{\text{max}}$: $d_p = 1 \text{ ft} + (4 * (38 \text{ cm} * 0.233) * 0.0328) = 2.2 \text{ ft}$. This value was rounded up to $d_p = 2.25 \text{ ft}$. Alewife is a schooling species and often aggregates in large numbers while resting in pools. Larger run sizes (hundreds to thousands) will require pools deeper than this minimum dimension. This depth guideline may not be feasible on very small-sized, first- and second-order streams with small watersheds (e.g., $<5 \text{ mi}^2$), limited stream flows, and smaller run sizes (hundreds of fish or less).

Minimum Pool/Channel Length: 10.0 ft

The guideline is based on creation of pools large enough to accommodate alewife body size, run size, and resting and schooling behavior, as well as meeting maximum weir opening velocity and maximum energy dissipation and slope guidelines. Alewife is a schooling species and often aggregates in large numbers while resting in pools. Larger run sizes (thousands or greater) will require pools longer than this minimum dimension.

Minimum Weir Opening Width: 2.50 ft

The guideline is based on a weir dimension wide enough to accommodate downstream movement of adult alewife oriented in a “worst case” perpendicular orientation to the flow, equivalent to 2 times TL_{max} or $2 * 38 \text{ cm} = 76 \text{ cm} = 2.49 \text{ ft}$. This value was rounded up to $W_N = 2.50 \text{ ft}$. In the case of larger stream populations (thousands or greater), entrance dimensions should be increased above 2.5 ft or multiple openings should be constructed in weirs to accommodate large numbers of fish simultaneously passing through the weir opening(s).

Minimum Weir Opening Depth: 1.0 ft

The guideline is based on provision of sufficient water depth over the weir to enable protection from terrestrial predators, maneuvering in low flows, and use of lower velocity zone in high flows; equivalent to 3 times BD_{max} : $3 * 8.86 \text{ cm} = 26.6 \text{ cm} = 0.87 \text{ ft}$. This value was rounded up to $d_N = 1.0 \text{ ft}$.

Maximum Weir Opening Water Velocity: 6.0 ft/sec

The guideline is based on laboratory sprint swimming studies in an open channel test flume (Haro et al. 2004, Castro-Santos 2005): $U=5.5 \text{ BL/sec}$ swimming speed for a maximum 60 sec. Therefore $U_{\text{max}} = 5.5 * 22 \text{ cm} = 121 \text{ cm/sec} = 3.97 \text{ ft/sec}$. In contrast, field observations have revealed adult alewives may ascend surface weirs in technical fishways at velocities of 8.0 ft/sec or higher (Reback et al. 2004) . To address the varying test data available, V_{max} was established at 6.0 ft/sec.

Maximum Fishway/Channel Slope: 1:20

This nominal slope guideline approximates the maximum slope at natural river sites known to be passable by alewife (Franklin et al. 2012), or is a conservative estimate of maximum slope based on known alewife swimming behavior and river hydro-geomorphologies in which alewives occur.

Hickory Shad

$TL_{min} = 28 \text{ cm}$ (Collette and Klein-MacPhee 2002)

$TL_{max} = 60 \text{ cm}$ (Klauda et al. 1991)

Body Depth/TL Ratio = 0.221 (FishBase; www.fishbase.org; BD = 22.1% of TL)

Minimum Pool/Channel Width: 20.0 ft

The guideline is based on creation of pools large enough to serve as resting areas and protection from terrestrial predators. Hickory shad is a schooling species and often aggregates in large numbers while resting in pools. Larger run sizes (hundreds to thousands) will require pools wider than this minimum dimension.

Minimum Pool/Channel Depth: 2.75 ft

The guideline is based on creation of pools large enough to serve as resting areas and protection from terrestrial predators. Minimum pool depth was calculated using the formula $1 \text{ ft} + 4BD_{max}$: $d_p = 1 \text{ ft} + (4 * (60 \text{ cm} * 0.221) * 0.0328) = 2.7 \text{ ft}$. This value was rounded up to $d_p = 2.75 \text{ ft}$. Hickory shad is a schooling species and often aggregates in large numbers while resting in pools. Larger run sizes (hundreds to thousands) will require pools deeper than this minimum dimension.

Minimum Pool/Channel Length: 40.0 ft

The guideline is based on creation of pools large enough to accommodate shad body size, run size, and resting and schooling behavior, as well as meeting maximum weir opening velocity and maximum energy dissipation and slope guidelines. Hickory shad is a schooling species and often aggregates in large numbers while resting in pools. Larger run sizes (hundreds to thousands) will require pools longer than this minimum dimension.

Minimum Weir Opening Width: 4.0 ft

The guideline is based on a weir dimension wide enough to accommodate downstream movement of adult hickory shad oriented in a “worst case” perpendicular orientation to the flow, equivalent to 2 times TL_{max} or $2 * 60 \text{ cm} = 120 \text{ cm} = 3.94 \text{ ft}$. This value was rounded up to $W_N = 4.00 \text{ ft}$. In the case of larger populations (thousands or greater), entrance dimensions should be greater than 4.00 ft, or multiple openings should be constructed in weirs to accommodate multiple shad simultaneously passing through weir opening(s).

Minimum Weir Opening Depth: 1.5 ft

The guideline is based on provision of sufficient water depth over the weir to enable protection from terrestrial predators, maneuvering in low flows, and use of lower velocity zone in high

flows; equivalent to 3 times $BD_{max} = 3 * 13.3 \text{ cm} = 39.8 \text{ cm} = 1.31 \text{ ft}$. This value was rounded up to $d_N = 1.50 \text{ ft}$.

Maximum Weir Opening Water Velocity: 4.5 ft/sec

No sprint swimming data are available for hickory shad. U_{crit} for hickory shad is unknown. Based on $U=5 \text{ BL/sec}$ for subcarangiform swimmers, $U_{max} = 5 * 28 \text{ cm} = 140 \text{ cm/sec} = 4.59 \text{ ft/sec}$. This value was rounded down to $V_{max} = 4.50 \text{ ft/sec}$.

Maximum Fishway/Channel Slope: 1:30

This nominal slope guideline approximates the maximum slope at natural river sites known to be passable by hickory shad, or is a conservative estimate of maximum slope based on known hickory shad swimming behavior and river hydro-geomorphologies in which hickory shad occur.

American Shad

$TL_{min} = 36 \text{ cm}$ (MacKenzie 1985)

$TL_{max} = 76 \text{ cm}$ (Klauda et al. 1991)

Body Depth/TL Ratio = 0.292 (A. Haro, USGS, unpub. data (Connecticut River fish))

Minimum Pool/Channel Width: 20.0 ft

The guideline is based on creation of pools large enough to serve as resting areas and protection from terrestrial predators. American shad is a schooling species and often aggregates in large numbers while resting in pools. Larger run sizes (hundreds to thousands) will require pools wider than this minimum dimension, typically on moderate to large-sized Atlantic Coast rivers (i.e., >200-1,000+ mi^2 watersheds).

Minimum Pool/Channel Depth: 4.0 ft

The guideline is based on creation of pools large enough to serve as resting areas and protection from terrestrial predators. Minimum pool depth was calculated using the formula $1 \text{ ft} + 4BD_{max}$: $d_p = 1 \text{ ft} + (4 * (76 \text{ cm} * 0.292) * 0.0328) = 3.9 \text{ ft}$. This value was rounded up to $d_p = 4.0 \text{ ft}$. American shad is a schooling species and often aggregates in large numbers while resting in pools. Larger run sizes (hundreds to thousands) will require pools deeper than this minimum dimension, typically on moderate to larger-sized rivers (i.e., >200-1,000+ mi^2 watersheds).

Minimum Pool/Channel Length: 30.0 ft

The guideline is based on creation of pools large enough to accommodate shad body size, run size, and resting and schooling behavior, as well as meeting maximum weir opening velocity and maximum energy dissipation and slope guidelines. American shad is a schooling species and often aggregates in large numbers while resting in pools. Larger run sizes (thousands or greater) will require pools longer than this minimum dimension, typically on moderate to large-sized rivers (i.e., >200-1,000+ mi^2 watersheds).

Minimum Weir Opening Width: 5.0 ft

The guideline is based on a weir dimension wide enough to accommodate downstream movement of adult American shad oriented in a “worst case” perpendicular orientation to the flow, equivalent to 2 times TL_{max} or $2 * 76 \text{ cm} = 152 \text{ cm} = 4.99 \text{ ft}$. This value was rounded up to $W_N = 5.00 \text{ ft}$. In the case of larger populations (thousands or greater), entrance dimensions should be greater than 5.00 ft or multiple openings should be constructed. Multiple fish simultaneously passing through weir openings are frequently observed in passage structures designed for large runs of American shad (Haro and Kynard 1997).

Note, in the southern portion of its range, particularly from Florida north to North Carolina, mature American shad are somewhat smaller (lengths: 35-47 cm; 1.2-1.6 ft) and have a higher percentage of single-time spawners than adult shad comprising more northerly populations (Facey and Van Den Avyle 1986). South of Cape Hatteras, North Carolina, American shad die after spawning (termed, semelparous), with increasing repeat spawning (iteroparous) with increasing latitude north of Cape Hatteras (Leggett and Carscadden 1978).

Minimum Weir Opening Depth: 2.25 ft

The guideline is based on provision of sufficient water depth over the weir to enable protection from terrestrial predators, maneuvering in low flows, and use of lower velocity zone in high flows; equivalent to 3 times BD_{max} : $3 * 22.2 \text{ cm} = 66.6 \text{ cm} = 2.18 \text{ ft}$. This value was rounded up to $d_N = 2.25 \text{ ft}$. As noted above, smaller-sized adults in the southern Atlantic Coast populations may support a lesser passage opening depth based on the body depth of adults in these populations.

Maximum Weir Opening Water Velocity: 8.25 ft/sec

The guideline is based on laboratory sprint swimming studies in an open channel test flume (Haro et al. 2004; Castro-Santos 2005): $U = 7.0 \text{ BL/sec}$ swimming speed for a maximum 60 sec. Therefore $U_{max} = 7.0 * 36 \text{ cm} = 252 \text{ cm/sec} = 8.27 \text{ ft/sec}$. This value was rounded down to $V_{max} = 8.25 \text{ ft/sec}$.

Maximum Fishway/Channel Slope: 1:30

This nominal slope guideline approximates the maximum slope at natural river sites known to be passable by American shad, or is a conservative estimate of maximum slope based on known American shad swimming behavior and river hydro-geomorphologies in which shad occur.

Gizzard Shad

$TL_{min} = 25 \text{ cm}$ (Miller 1960)

$TL_{max} = 50 \text{ cm}$ (Able and Fahay 2010)

Body Depth/TL Ratio = 0.323 (FishBase; www.fishbase.org; $BD = 32.3\%$ of TL)

Minimum Pool/Channel Width: 20.0 ft

The guideline is based on creation of pools large enough to serve as resting areas and protection from terrestrial predators. Gizzard shad is a schooling species and often aggregates

in large numbers while resting in pools. Larger run sizes (hundreds to thousands) will require pools wider than this minimum dimension.

Minimum Pool/Channel Depth: 3.25 ft

The guideline is based on creation of pools large enough to serve as resting areas and protection from terrestrial predators. Minimum pool depth was calculated using the formula $1 \text{ ft} + 4BD_{\text{max}}$: $d_p = 1 \text{ ft} + (4 * (50 \text{ cm} * 0.323) * 0.0328) = 3.1 \text{ ft}$. This value was rounded up to $d_p = 3.25 \text{ ft}$. Gizzard shad is a schooling species and often aggregates in large numbers while resting in pools. Larger run sizes (hundreds to thousands) will require pools deeper than this minimum dimension.

Minimum Pool/Channel Length: 40.0 ft

The guideline is based on creation of pools large enough to accommodate shad body size, run size, and resting and schooling behavior, as well as meeting maximum weir opening velocity and maximum energy dissipation and slope guidelines. Gizzard shad is a schooling species and often aggregates in large numbers while resting in pools. Larger run sizes (thousands or greater) will require pools longer than this minimum dimension.

Minimum Weir Opening Width: 3.5 ft

The guideline is based on a weir dimension wide enough to accommodate downstream movement of adult gizzard shad in a “worst case” perpendicular orientation to the flow, equivalent to 2 times TL_{max} or $2 * 50 \text{ cm} = 100 \text{ cm} = 3.28 \text{ ft}$. This value was rounded up to $W_N = 3.5 \text{ ft}$. In the case of larger populations (thousands or greater), entrance dimensions should be greater than 3.5 ft or multiple openings provided to accommodate multiple fish simultaneously passing through the weir opening(s).

Minimum Weir Opening Depth: 1.75 ft

The guideline is based on provision of sufficient water depth over the weir to enable protection from terrestrial predators, maneuvering in low flows, and use of lower velocity zone in high flows; equivalent to 3 times BD_{max} : $3 * 16.2 = 48.5 \text{ cm} = 1.59 \text{ ft}$, to provide additional depth for maneuvering, passage by shad schools, and use of lower velocity zone. This value was rounded up to $d_N = 1.75 \text{ ft}$.

Maximum Weir Opening Water Velocity: 4.0 ft/sec

No known sprint swimming data are available for gizzard shad; U_{crit} for gizzard shad is unknown. The guideline is therefore based on $U = 5 \text{ BL/sec}$ for subcarangiform swimmers; $U_{\text{max}} = 5 * 25 \text{ cm} = 125 \text{ cm/sec} = 4.10 \text{ ft/sec}$. This value was rounded down to $V_{\text{max}} = 4.0 \text{ ft/sec}$.

Maximum Fishway/Channel Slope: 1:30

This nominal slope guideline approximates the maximum slope at natural river sites known to be passable by gizzard shad, or is a conservative estimate of maximum slope based on known gizzard shad swimming behavior and river hydro-geomorphologies in which gizzard shad occur.

Rainbow Smelt

$TL_{min} = 12$ cm (C. Enterline, Maine Department of Marine Resources, unpub. data)

$TL_{max} = 28$ cm (C. Enterline, Maine Department of Marine Resources, unpub. data; Data from O'Malley (2016) for anadromous smelt from four Maine rivers (2010-2014) indicate maximum length of 24 cm, perhaps suggesting a temporal trend in decreasing mean length in Northeast smelt populations)

Body Depth/TL Ratio = 0.129 (FishBase; www.fishbase.org; BD = 12.9% of TL)

Minimum Pool/Channel Width: 5.0 ft

The guideline is based on creation of pools large enough to serve as resting areas and protection from terrestrial predators. Rainbow smelt is a schooling species and often aggregates in large numbers while resting in pools. Larger run sizes (hundreds to thousands) will require pools wider than this minimum dimension.

Minimum Pool/Channel Depth: 1.5 ft

The guideline is based on creation of pools large enough to serve as resting areas and protection from terrestrial predators. Minimum pool depth was calculated using the formula $d_p = 1 \text{ ft} + 4BD_{max}$: $d_p = 1 \text{ ft} + (4 * (28 \text{ cm} * 0.129) * 0.0328) = 1.5 \text{ ft}$. Rainbow smelt is a schooling species and often aggregates in large numbers while resting in pools. Larger run sizes (hundreds to thousands) will require pools deeper than this minimum dimension.

Minimum Pool/Channel Length: 10.0 ft

The guideline is based on creation of pools large enough to accommodate fish size, run size, and resting and schooling behavior, as well as meeting minimum weir velocity and maximum energy dissipation and slope guidelines. Rainbow smelt is a schooling species and often aggregates in large numbers while resting in pools. Larger run sizes (hundreds to thousands) will require pools longer than this minimum dimension.

Minimum Weir Opening Width: 1.0 ft

The guideline is based on a weir dimension wide enough to accommodate downstream movement of adult rainbow smelt in a "worst case" perpendicular orientation to the flow, equivalent to 2 times TL_{max} or $2 * 28 \text{ cm} = 56 \text{ cm} = 1.84 \text{ ft}$. This value was reduced to $W_N = 1.0 \text{ ft}$ to offset potential flow limitations during low fish-run flow periods for passageways on small to very small (first or second-order) coastal streams where wider openings may result in shallow water depths not meeting the passage opening depth guideline (See minimum weir opening depth guideline, below). In the case of larger populations (thousands or greater), entrance dimensions should be greater than 1.0 ft to accommodate multiple fish simultaneously passing through the weir opening.

Minimum Weir Opening Depth: 0.50 ft

The guideline is based on provision of sufficient water depth over the weir to enable protection from terrestrial predators, maneuvering in low flows, and use of lower velocity zone in high flows; equivalent to 3 times BD_{max} : $3 * 3.6 \text{ cm} = 10.8 \text{ cm} = 0.35 \text{ ft}$. This value was rounded up to $d_N = 0.50 \text{ ft}$.

Maximum Weir Opening Water Velocity: 3.25 ft/sec

The guideline is based on mean $U_{crit} = 0.30$ m/s for 7 cm, smaller-sized adult rainbow smelt in respirometer experiments (Griffiths 1979); $U_{crit} = 4.29$ BL/sec. Therefore $U_{max} = 2 * 4.29 * 12$ cm = 103.0 cm/sec = 3.38 ft/sec. Velocity barriers have been observed for rainbow smelt at water velocities greater than 3.9 ft/sec (B. Chase, MADMF, pers. comm., 8/30/2011). V_{max} was rounded down to 3.25 ft/sec.

Maximum Fishway/Channel Slope: 1:30

Rainbow smelt spawning runs are typically associated with low-gradient streams and rivers near the head-of-tide. Slope guidelines have not been previously established for rainbow smelt, so a conservative slope was selected. This nominal slope guideline approximates the maximum slope at natural river sites known to be passable by rainbow smelt, or is a conservative estimate of maximum slope based on known rainbow smelt swimming behavior and river hydro-geomorphologies in which smelt occur.

Atlantic Salmon

$TL_{min} = 70$ cm (T. Sheehan, NMFS, unpub. data)

$TL_{max} = 95$ cm (T. Sheehan, NMFS, unpub. data)

Body Depth/TL Ratio = 0.215 (T. Sheehan, NMFS, unpub. data; these data were applied to best represent current Northeastern U.S. populations)

Minimum Pool/Channel Width: 20.0 ft

The guideline is based on creation of pools large enough to serve as resting areas and protection from terrestrial predators.

Minimum Pool/Channel Depth: 3.75 ft

The guideline is based on creating pools large enough to serve as resting areas and protection from terrestrial predators. Minimum pool depth was calculated using the formula $1 \text{ ft} + 4BD_{max}$: $d_p = 1 \text{ ft} + (4 * (95 \text{ cm} * 0.215) * 0.0328) = 3.7 \text{ ft}$. This value was rounded up to $d_p = 3.75 \text{ ft}$.

Minimum Pool/Channel Length: 40.0 ft

The guideline is based on creation of pools large enough to accommodate salmon body size, run size, and resting and schooling behavior, as well as meeting maximum weir opening velocity and maximum energy dissipation and slope guidelines.

Minimum Weir Opening Width: 6.25 ft

The guideline is based on a weir opening dimension wide enough to accommodate downstream movement of adult Atlantic salmon in a “worst case” perpendicular orientation to the flow, equivalent to 2 times TL_{max} or $2 * 95 \text{ cm} = 190 \text{ cm} = 6.23 \text{ ft}$. This value was rounded up to $W_N = 6.25 \text{ ft}$. This width dimension may be reduced to offset potential flow limitations not meeting the minimum weir opening water depth guideline (See water depth guideline, below) associated with low-flow (e.g., autumn post-spawn downstream passage) conditions during the passage season.

Minimum Weir Opening Depth: 2.25 ft

The guideline is based on provision of sufficient water depth over the weir to enable protection from terrestrial predators, maneuvering in low flows, and use of lower velocity zone in high flows; equivalent to 3 times BD_{max} : $3 * 20.41 \text{ cm} = 61.2 \text{ cm} = 2.01 \text{ ft}$. This value was rounded up to $d_N = 2.25 \text{ ft}$.

Maximum Weir Opening Water Velocity: 13.75 ft/sec

The guideline is based initially on mean $U_{crit} = 1.70 \text{ m/s}$ for 57 cm adult Atlantic salmon in respirometer experiments (Booth et al. 1997). The 57 cm body length approximates the smallest-sized, sea-run adult salmon (grilse) and is not based on smaller-sized spawning adult landlocked salmon; $U_{crit} = 3.0 \text{ BL/sec}$. Therefore, $U_{max} = 2 * 3.0 * 70 \text{ cm} = 420 \text{ cm/sec} = 13.78 \text{ ft/sec}$. This value was rounded down to $V_{max} = 13.75 \text{ ft/sec}$.

Maximum Fishway/Channel Slope: 1:20

This nominal slope guideline approximates the maximum slope at natural river sites known to be passable by Atlantic salmon, or is a conservative estimate of maximum slope based on known Atlantic salmon swimming and leaping behavior and river hydro-geomorphologies in which Atlantic salmon occur.

Sea-Run Brook Trout

$TL_{min} = 10 \text{ cm}$ (M. Gallagher, Maine Department of Inland Fisheries, unpub. data)

$TL_{max} = 45 \text{ cm}$ (M. Gallagher, Maine Department of Inland Fisheries, unpub. data)

Body Depth/TL Ratio = 0.255 (M. Gallagher, Maine Dept. Inland Fisheries, unpub. data)

Minimum Pool/Channel Width: 5.0 ft

The guideline is based on creating pools large enough to serve as resting areas and protection from terrestrial predators. Streams and rivers with larger runs (hundreds or more) will require greater passage widths.

Minimum Pool/Channel Depth: 2.5 ft

The guideline is based on creating pools large enough to serve as resting areas and protection from terrestrial predators, as well as accommodating trout leaping capabilities and needs for passing over weirs or through openings. Minimum pool depth was calculated using the formula $1 \text{ ft} + 4BD_{max}$: $d_p = 1 \text{ ft} + (4 * (45 \text{ cm} * 0.255) * 0.0328) = 2.5 \text{ ft}$.

Minimum Pool/Channel Length: 10.0 ft

The guideline is based on creation of pools large enough to accommodate trout body size, run size, and resting and schooling behavior, as well as meeting maximum weir opening velocity and maximum energy dissipation and slope guidelines.

Minimum Weir Opening Width: 1.5 ft

The guideline is based on a weir dimension wide enough to accommodate downstream movement of adult sea-run brook trout in a “worst case” perpendicular orientation to the flow,

equivalent to 2 times TL_{max} or $2 * 45 \text{ cm} = 90 \text{ cm} = 2.95 \text{ ft}$. However, this dimension was reduced to $W_N = 1.5 \text{ ft}$ to offset potential flow limitations not meeting the minimum weir opening water depth guideline (See minimum weir opening water depth guideline, below) associated with low-flow (e.g., autumn post-spawn downstream passage) conditions during the passage season for passages on small or very small (first or second-order) coastal streams.

Minimum Weir Opening Depth: 1.25 ft

The guideline is based on provision of sufficient water depth through the weir opening to enable protection from terrestrial predators, maneuvering in low flows, and use of lower velocity zone in high flows; equivalent to 3 times BD_{max} : $3 * 11.5 \text{ cm} = 34.4 \text{ cm} = 1.12 \text{ ft}$. This value was rounded up to $d_N = 1.25 \text{ ft}$.

Maximum Weir Opening Water Velocity: 3.25 ft/sec

The guideline is based initially on laboratory sprint swimming studies in an open channel flume (Castro-Santos et al. 2013): $U=10.0 \text{ BL/sec}$ swimming speed for a maximum 60 sec. Therefore, $U_{max} = 10.0 * 10 \text{ cm} = 100 \text{ cm/sec} = 3.28 \text{ ft/sec}$. This value was rounded down to $V_{max} = 3.25 \text{ ft/sec}$.

Maximum Fishway/Channel Slope: 1:20

This nominal slope guideline approximates the maximum slope at natural river sites known to be passable by sea-run brook trout, or is a conservative estimate of maximum slope based on known brook trout swimming behavior and river hydro-geomorphologies in which brook trout occur.

Smaller-sized Salmonids $\leq 20 \text{ cm}$ ($\leq 8 \text{ inch}$) TL

$TL_{min} = 5 \text{ cm}$ (lower limit of specified range)

$TL_{max} = 20 \text{ cm}$ (upper limit of specified range)

Body Depth/TL Ratio = 0.250 (generalized BD/TL ratio)

We present guidelines for smaller-sized salmonids which may include both non-migratory phase Atlantic salmon parr (juveniles) using low-order, high-gradient streams with limited seasonal flows; and native sea-run brook trout which may mature as adults as small as 8.5-cm length, and are typically found in Northeast streams and rivers at smaller-size lengths.

Minimum Pool/Channel Width: 5.0 ft

The guideline is based on creating pools large enough to serve as resting areas and protection from terrestrial predators.

Minimum Pool/Channel Depth: 1.75 ft

The guideline is based on creating pools large enough to serve as resting areas and protection from terrestrial predators, as well as accommodating leaping capabilities and needs of juvenile salmonids. Minimum pool depth was calculated using the formula $1 \text{ ft} + 4BD_{max}$: $d_p = 1 \text{ ft} + (4 * (20 \text{ cm} * 0.250) * 0.0328) = 1.7 \text{ ft}$. This value was rounded up to $d_p = 1.75 \text{ ft}$.

Minimum Pool/Channel Length: 10.0 ft

The guideline is based on creation of pools large enough to accommodate fish size, run size, and resting and schooling behavior, as well as meeting maximum weir opening velocity and maximum energy dissipation and slope guidelines.

Minimum Weir Opening Width: 1.25 ft

The guideline is based on a weir dimension wide enough to accommodate downstream movement of upstream passage by a larger juvenile or young adult, and the downstream movement of juvenile salmonids and smolts in a “worst case” perpendicular orientation to the flow, equivalent to 2 times TL_{max} of 20 cm: = 40 cm = 1.31 ft. However this value was rounded down to $W_N = 1.25$ ft to offset potential flow limitations not meeting the minimum weir opening water depth guideline (See minimum weir opening water depth guideline, below) associated with low fish-run flow conditions for passageways on small or very small (first or second-order) coastal streams and streams with substantially varying (“flashy”) seasonal flow conditions.

Minimum Weir Opening Depth: 0.50 ft

The guideline is based on provision of sufficient water depth through the weir opening to enable protection from terrestrial predators, maneuvering in low flows, and use of lower velocity zone in high flows; equivalent to 3 times BD_{max} : $3 * 5.0$ cm = 15.0 cm = 0.49 ft. This value was rounded up to $d_N = 0.50$ ft.

Maximum Weir Opening Water Velocity: 2.25 ft/sec

The guideline is based on mean $U_{crit} = 0.62$ m/s for 8.5 cm brook trout in respirometer experiments (McDonald et al. 1998); $U = 7.3$ BL/sec. This guideline is based on the approximate smallest body length for adult brook trout. Therefore, $U_{max} = 2 * 7.3 * 5.0$ cm = 73.0 cm/sec = 2.40 ft/sec. This value was rounded down to $V_{max} = 2.25$ ft/sec.

Maximum Fishway/Channel Slope: 1:20

This nominal slope guideline approximates the maximum slope at natural river sites known to be passable by juvenile salmonids, or is a conservative estimate of maximum slope based on known salmonid swimming and leaping behavior and river hydro-geomorphologies in which salmonids occur.

Atlantic Tomcod

$TL_{min} = 15$ cm (Collette and Klein-MacPhee 2002)

$TL_{max} = 30$ cm (Collette and Klein-MacPhee 2002, Stevens et al., 2016)

Body Depth/TL Ratio = 0.202 (FishBase; www.fishbase.org; $BD = 20.2\%$ of TL)

Minimum Pool/Channel Width: 5.0 ft

The guideline is based on creating pools large enough to serve as resting areas and protection from terrestrial predators.

Minimum Pool/Channel Depth: 2.0 ft

The guideline is based on creating pools large enough to serve as resting areas and protection from terrestrial predators. Minimum pool depth was calculated using the formula $1 \text{ ft} + 4BD_{\text{max}}$: $d_p = 1 \text{ ft} + (4 * (30 \text{ cm} * 0.202) * 0.0328) = 1.8 \text{ ft}$. This value was rounded up to $d_p = 2.0 \text{ ft}$.

Minimum Pool/Channel Length: 10.0 ft

The guideline is based on creation of pools large enough to accommodate tomcod body size, run size, and resting and schooling behavior, as well as meeting maximum weir opening velocity and maximum energy dissipation and slope guidelines.

Minimum Weir Opening Width: 2.0 ft

The guideline is based on a weir dimension wide enough to accommodate upstream passage by multiple adult Atlantic tomcod migrating upstream in small tidal, coastal streams, including during ebbing-tide periods in tidal streams; as well as downstream movement of adult Atlantic tomcod in a “worst case” perpendicular orientation to the flow; equivalent to 2 times TL_{max} or $2 * 30 \text{ cm} = 60 \text{ cm} = 1.97 \text{ ft}$. This value was rounded up to $W_N = 2.0 \text{ ft}$.

Minimum Weir Opening Depth: 0.75 ft

The guideline is based on provision of sufficient water depth through the weir opening to enable protection from terrestrial predators, maneuvering in low flows, and use of lower velocity zone in high flows; equivalent to 3 times BD_{max} : $3 * 6.06 \text{ cm} = 18.2 \text{ cm} = 0.60 \text{ ft}$. This value was rounded up to $d_N = 0.75 \text{ ft}$.

Maximum Weir Opening Water Velocity: 0.75 ft/sec

No sprint swimming data are available for Atlantic tomcod. U_{crit} for Atlantic tomcod is unknown. Water velocities in excess of 30 cm/sec are known to be barriers for Atlantic tomcod (Bergeron et al. 1998); therefore, $U_{\text{max}} = 30 \text{ cm/sec} = 0.98 \text{ ft/sec}$. This value was rounded down to $V_{\text{max}} = 0.75 \text{ ft/sec}$. If a passage site is affected by tidal flooding, tom cod may alternatively passively move over project site weirs or through weir openings or other hydraulic features during diurnal flood tide events.

Maximum Fishway/Channel Slope: 1:30

This nominal slope guideline approximates the maximum slope at natural river sites known to be passable by tom cod, or is a conservative estimate of maximum slope based on known tom cod swimming behavior and river hydro-geomorphologies in which tom cod occur.

Striped Bass

$TL_{\text{min}} = 15 \text{ cm}$ (Fay et al. 1983)

$TL_{\text{max}} = 30 \text{ cm}$ (Collette and Klein-MacPhee 2002)

Body Depth/TL Ratio = 0.225 (FishBase; www.fishbase.org; $BD = 22.5\%$ of TL)

Minimum Pool/Channel Width: 20.0 ft

The guideline is based on creating pools large enough to serve as resting areas and protection from terrestrial predators.

Minimum Pool/Channel Depth: 5.25 ft

The guideline is based on creating pools large enough to serve as resting areas and protection from terrestrial predators. Minimum pool depth was calculated using the formula $1 \text{ ft} + 4BD_{\text{max}}$:
 $d_p = 1 \text{ ft} + (4 * (140 \text{ cm} * 0.225) * 0.0328) = 5.1 \text{ ft}$. This value was rounded up to $d_p = 5.25 \text{ ft}$.

Minimum Pool/Channel Length: 30.0 ft

The guideline is based on creation of pools large enough to accommodate bass body size, run size, and resting and schooling behavior, as well as meeting maximum weir opening velocity and maximum energy dissipation and slope guidelines.

Minimum Weir Opening Width: 9.25 ft

The guideline is based on a weir dimension wide enough to accommodate upstream migration by adult striped bass on migratory spawning runs (principally tidal rivers with varying tidal prism, or larger (fourth+-order) non-tidal rivers); and downstream movement of adult striped bass in a “worst case” perpendicular orientation to the flow; equivalent to at least 2 times TL_{max} or $2 * 140 \text{ cm} = 280 \text{ cm} = 9.19 \text{ ft}$. This value was rounded up to $W_N = 9.25 \text{ ft}$.

Minimum Weir Opening Depth: 3.25 ft

The guideline is based on provision of sufficient water depth over the weir to enable protection from terrestrial predators, maneuvering in low flows, and use of lower velocity zone in high flows; equivalent to 3 times BD_{max} : $3 * 31.5 \text{ cm} = 94.5 \text{ cm} = 3.10 \text{ ft}$. This value was rounded up to $d_N = 3.25 \text{ ft}$.

Maximum Weir Opening Water Velocity: 5.25 ft/sec

The guideline is based on laboratory sprint swimming studies in an open channel test flume (Haro et al. 2004; Castro-Santos 2005): $U = 4.0 \text{ BL/sec}$ swimming speed for a maximum 60 sec. Therefore $U_{\text{max}} = 4.0 * 40 \text{ cm} = 160 \text{ cm/sec} = 5.25 \text{ ft/sec}$. V_{max} was therefore established as 5.25 ft/sec for smaller-sized striped bass.

Maximum Fishway/Channel Slope: 1:30

This nominal slope guideline approximates the maximum slope at natural river sites known to be passable by striped bass, or is a conservative estimate of maximum slope based on known striped bass swimming behavior and river hydro-geomorphologies in which striped bass occur.

References

- Aadland, L. 1993. Stream habitat types: Their fish assemblages and relationship to flow. *North American Journal of Fisheries Management* 13: 790-806.
- Aadland, L. 2010. *Reconnecting Rivers: Natural Channel Design in Dam Removal and Fish Passage*. Minnesota Department of Natural Resources. First Edition. 196 pp.
- Able, K. W., and M. P. Fahay. 2010. *Ecology of Estuarine Fishes*. Johns Hopkins University Press. 584 pp.
- Ames, E.P. 2004. Atlantic cod structure in the Gulf of Maine. *Fisheries* 29: 10-28.
- Atlantic States Marine Fisheries Commission (ASMFC). 2008. ASMFC workshop on fish passage issues impacting Atlantic coast states. April 3 and 4, 2008. Jacksonville, FL. 260 pp.
- ASMFC. 2009. Atlantic coast diadromous fish habitat: A review of utilization, threats, recommendations for conservation, and research needs. *Habitat Management Series #9*. January 2009. 464 pp.
- ASMFC. 2010. Upstream fish passage technologies for managed species. Fish Passage Working Group. September 2010. 16 pp.
- ASMFC. 2012. River herring benchmark stock assessment. Volume II. Stock Assessment Report No. 12-02 of the Atlantic States Marine Fisheries Commission. 707 pp.
- Bainbridge, R. 1958. The speed of swimming of fish as related to size and to the frequency and amplitude of the tail beat. *J. Exp. Biol.* 33: 109-133.
- Bates, K. M, R. J. Barnard, B. Heiner, J. P. Klavas, and P. D. Powers. 2003. *Design of road culverts for fish passage*. Washington Department of Fish and Wildlife, Olympia, WA.
- Beach, M.A. 1984. *Fish Pass Design*. Fisheries Research Technical Report No. 78. Guidelines for the Design and Approval of Fish Passes and Other Structures to Facilitate the Passage of Migratory Fish in Rivers. Lowestoft, United Kingdom. Ministry of Agriculture, Fisheries and Food. 44 pp.
- Beamish, F. W. H. 1978. Swimming capacity. Pp. 101-187 *In: Fish Physiology, Vol. III, Locomotion*. W. S. Hoar and D. J. Randall, eds. Academic Press, London.
- Bell, M. 1991. *Fisheries Handbook of Engineering Requirements and Biological Guidelines*. U.S. Army Corps of Engineers, North Pacific Division, Fish Development and Evaluation Program, 1991. Portland, OR. 35 chapters.

- Bergeron, N. E., A. G. Roy, D. Chaumont, Y. Mailhot, and E. Guay 1998. Winter geomorphological processes in the Saint-Anne River (Quebec) and their impact on the migratory behaviour of Atlantic tomcod (*Microgadus tomcod*). *Regulated Rivers Research and Management* 14: 95-105.
- Booth, R. K., R. S. McKinley, F. Okland, and M. M. Sisak. 1997. In situ measurement of swimming performance of wild Atlantic salmon (*Salmo salar*) using radio transmitted electromyogram signals. *Journal of Aquatic Living Resources* 10:213-19.
- Brown, J.H. 1995. Organisms as engineers: a useful framework for studying effects of ecosystems? *Trends in Ecology and Evolution* 10:51-52.
- California Department of Fish and Game. 2009. California Salmonid Stream Habitat Restoration Manual. Part XII. Fish Passage Design and Implementation. 189 pp.
- Castro-Santos, T. 2005. Optimal swim speeds for traversing velocity barriers: an analysis of volitional high-speed swimming behavior of migratory fishes. *Journal of Experimental Biology* 208, 421-432.
- Castro-Santos, T. and A. Haro 2006. Biomechanics and fisheries conservation. Pp. 469-523 In: G.C. Lauder and R.E. Shadwick, eds. *Fish Physiology, Volume 23: Fish Biomechanics*, Academic Press, New York.
- Castro-Santos, T. and A. Haro. 2010. Fish guidance and passage at barriers. Pp. 62-89 In: P. Domeneci and B. G. Kapoor, eds. *Fish Locomotion: An Eco-Ethological Perspective*. Science Publishers, Enfield, New Hampshire. 534 pp.
- Castro-Santos, T., J. Sanz-Ronda, and J. Ruiz-Legazpi. 2013. Breaking the speed limit – comparative sprinting performance of brook trout (*Salvelinus fontinalis*) and brown trout (*Salmo trutta*). *Canadian Journal of Fisheries and Aquatic Sciences* 70(2): 280-293. doi:10.1139/cjfas-2012-0186.
- Clay, C.H. 1995. *Design of Fishways and Other Fish facilities*. 2nd Edition. CRC Press, Lewis Publishers, Boca Raton, Florida. 248 pp.
- Collette, B.B. and G. Klein-MacPhee. 2002. *Bigelow and Schroeder's Fishes of the Gulf of Maine*. 3rd Edition. Smithsonian Institution Press, Washington, D.C. and London, England. 748 pp.
- Collins, M.J. 2009. Evidence for changing flood risk in New England since the late 20th century. *Journal of the American Water Resources Association* 45: 279-290.
- Dadswell, M. J. 1979. Biology and population characteristics of the shortnose sturgeon, *Acipenser brevirostrum* LeSueur 1818 (Osteichthyes: Acipenseridae), in the Saint John River estuary, New Brunswick, Canada. *Canadian Journal of Zoology* 57: 2186-2210.

Ellis, D. and J.C. Vokoun. 2009. Earlier spring warming of coastal streams and implications for alewife migration timing. *North American Journal of Fisheries Management* 29: 1584-1589.

Facey, D.E. and M.J. Van Den Avyle. 1986. Species profiles: Life histories and environmental requirements of coastal fishes and invertebrates (South Atlantic): American shad. U.S. Fish and Wildlife Service Biological Report 82(11.45), TR EL-82-4. Coastal Ecology Group Waterways Experiment Station, U.S. Army Corps of Engineers and National Coastal Ecosystems Team, U.S. department of the Interior. 18 pp.

FAO. 2002. Fish Passes – Design, Dimensions and Monitoring. Published by the Food and Agriculture Organization of the United Nations in arrangement with Deutscher Verband für Wasserwirtschaft und Kulturbau e.V. (DVWK), Rome, 2002. FAO ISBN: 92-5-104894-0. 119 pp.

Fay, C. W., R. J. Neves, and G. B. Pardue 1983. Species Profiles. Life Histories and Environmental Requirements of Coastal Fishes and Invertebrates (Mid-Atlantic). Striped bass. Dept. of Fisheries and Wildlife Sciences, Virginia Polytechnic Institute and State University, Blacksburg, VA. 44 pp.

Franklin, A. E., A. Haro, T. Castro-Santos, and J. Noreika. 2012. Evaluation of nature-like and technical fishways for the passage of alewives (*Alosa pseudoharengus*) at two coastal streams in New England. *Transactions of the American Fisheries Society* 141(3): 624-637.

Freeman, M.C., C.M. Pringle, E.A. Greathouse, and B.J. Freeman. 2003. Eco-system-level consequences of migratory faunal depletion caused by dams. *American Fisheries Society Symposium* 35: 255-266.

Fried, H.A. and E.T. Schultz. 2006. Anadromous rainbow smelt and tom cod in Connecticut: Assessment of populations, conservation status, and needs for restoration plan. *EEB Articles*. Paper 18. http://digitalcommons.uconn.edu/eeb_articles/18.

Gillis, G. B. 1998. Environmental effects on undulatory locomotion in the American eel *Anguilla rostrata*: kinematics in water and on land. *Journal of Experimental Biology* 201, 949–961

Greenburg, P. 2010. *Four Fish: The Future of the Last Wild Food*. Penguin Books, New York, NY. 304 pp.

Griffiths, J. S. 1979. Effects of size and temperature on sustained swimming speeds of Great Lakes fishes. *Ontario Hydro Research Division Report*. 37 pp.

Guyette, M.Q., C.S. Loftin, and J. Zydlewski. 2013. Carcass analog addition enhances juvenile Atlantic salmon (*Salmo salar*) growth and condition. *Canadian Journal of Fish Aquatic Sciences* 70: 860–870. doi:10.1139/cjfas-2012-0496.

- Hall, C.J., A. Jordaan, and M.G. Frisk. 2011. The historic influence of dams on diadromous fish habitat with a focus on river herring and hydrologic longitudinal connectivity. *Landscape Ecology* 26: 95-107.
- Haro, A. J., and W. H. Krueger. 1991. Pigmentation, otolith rings, and upstream migration of juvenile American eels (*Anguilla rostrata*) in a coastal Rhode Island stream. *Canadian Journal of Zoology* 69(3): 812-814.
- Haro, A. and B. Kynard. 1997. Video evaluation of passage efficiency of American shad and sea lamprey in a modified Ice Harbor fishway. *North American Journal of Fisheries Management* 17: 981-987.
- Haro, A., T. Castro-Santos, J. Noreika, and M. Odeh. 2004. Swimming performance of upstream migrant fishes in open-channel flow: a new approach to predicting passage through velocity barriers. *Canadian Journal Fisheries and Aquatic Sciences* 61:1590–1601.
- Hogg, R. S., Coghlan, S. M., Zydlewski, J., and Simon, K. S. 2014. Anadromous sea lampreys (*Petromyzon marinus*) are ecosystem engineers in a spawning tributary. *Freshwater Biology* 59(6): 1294-1307.
- Huntington, T.G., G.A. Hodgkins, and R.W. Dudley. 2003. Historical trend in river ice thickness and coherence in hydroclimatical trends in Maine. *Climate Change* 61: 217-236.
- Juanes, F., S. Gephard, and K.F. Beland. 2004. Long-term changes in migration timing of adult Atlantic salmon (*Salmo salar*) at the southern end of the species distribution. *Canadian Journal of Fisheries and Aquatic Sciences* 61: 2392-2400.
- Klauda, R. J., Fischer, S. A., Hall Jr, L. W., & Sullivan, J. A. 1991. American shad and hickory shad. Habitat requirements for Chesapeake Bay living resources, 9-1. Maryland Department of Natural Resources. 27 pp.
- Kynard, B., D. Pugh, and T. Parker. 2012. Passage and behavior of Connecticut River shortnose sturgeon in a prototype spiral fish ladder with a note on passage of other fish species. Chapter 11. Pp. 277-296. In: Kynard, B. P. Bronzi, and H. Rosenthal (eds.). *Life History and Behaviour of Connecticut River Shortnose and Other Sturgeons*. World Sturgeon Conservation Society Publication n^o 4. 320 pp.
- Leggett, W.C. and J.E. Carscadden. 1978. Latitudinal variation in reproductive characteristics of American shad *Alosa sapidissima*: evidence for population specific life history strategies in fish. *Journal of Fisheries Research Board of Canada* 35: 1469-1478.
- Limburg, K. and J. Waldman. 2009. Dramatic declines of in North Atlantic diadromous fishes. *BioScience* 59: 955-965.

MacKenzie, C., L. S. Weiss-Glanz, and J. R. Moring. 1985. Species profiles: life histories and environmental requirements of coastal fishes and invertebrates (mid-Atlantic)-American shad. [*Alosa sapidissima*] (No. FWS/OBS-82-11.37; TR-EL-82-4-11.37). Maine Univ., Orono (USA). Maine Cooperative Fishery Research Unit.

Maine Department of Transportation (Maine DOT). 2008. Waterway and Wildlife Crossing Policy and Design Guide. 3rd Edition. 122 pp.

Martin, E. H. and C. D. Apse. 2011. Northeast Aquatic Connectivity: An Assessment of Dams on Northeastern Rivers. The Nature Conservancy, Eastern Freshwater Program. 98 pp.

McAuley, T. C. 1996. Development of an instream velocity barrier to stop sea lamprey (*Petromyzon marinus*) migrations in Great Lakes streams. MSc. Thesis, University of Manitoba, Winnipeg. 153pp.

McCleave, J. D. 1980. Swimming performance of European eel [*Anguilla anguilla* (L.)] elvers. *Journal of Fish Biology* 16: 445-452.

McDermott, S., N.C. Bransome, S.E. Sutton, B.E. Smith, J.S. Link, and T. J. Miller. 2015. Quantifying diadromous species in the diets of marine fishes in the Gulf of Maine. *Journal of Fish Biology*. Manuscript accepted.

McDonald, D. G., McFarlane, W. J., and Milligan, C. L. 1998. Anaerobic capacity and swim performance of juvenile salmonids. *Canadian Journal of Fisheries and Aquatic Sciences* 55: 1198-1207.

McPhee, J. 2003. *The Founding Fish*. Macmillan Publishers, New York, NY. 368 pp.

Miller, R. R. 1960. Systematics and biology of the gizzard shad (*Dorosoma cepedianum*) and related fishes. *Fisheries*, 1(2), 3.

Mooney, D.M., C.L. Holmquist-Johnson, and S. Broderick. 2007. Rock Ramp Design Guidelines. Reclamation – Managing Water in the West. U.S. Department of Interior, Bureau of Reclamation, Technical Service Center, Denver, CO. 102 pp. + appendices.

National marine Fisheries Service (NMFS). 1998. Final Recovery Plan for the Shortnose Sturgeon, *Acipenser brevirostrum*. December 1998. Prepared by the Shortnose Sturgeon Recovery Team for the National Marine Fisheries Service, Silver Spring, Maryland. 104 pages.

NMFS. 2006. Endangered and Threatened Species; Revision of Species of Concern List, Candidate Species Definition, and Candidate Species List. 71 FR 61022-61025. October 17, 2006. See: <https://federalregister.gov/a/E6-17249>

NMFS. 2007. Rainbow smelt, *Osmerus mordax*. Species of Concern. Fact Sheet. See also: <http://www.fisheries.noaa.gov/pr/species/fish/rainbow-smelt.html>

NMFS. 2009. Endangered and threatened species; designation of critical habitat for Atlantic Salmon (*Salmo salar*) Gulf of Maine distinct population segment. Federal Register 74, No. 117: 29300-29341. June 19, 2009.

NMFS. 2011. Anadromous salmonid passage facility design. NMFS, Northwest Region (NWR), Portland, OR.

NMFS. 2013a. Endangered and threatened species; protective regulations for the Gulf of Maine distinct population segment of Atlantic Sturgeon. Federal Register 78, No. 223: 69310-69315. November 19, 2013.

NMFS. 2013b. Endangered and threatened wildlife and plants; Endangered Species Act listing determination for alewife and blueback herring. Federal Register 78, No. 155: 48944-48994. August 12, 2013.

Nedeau, E.J. 2008. Freshwater Mussels and the Connecticut River Watershed. In Cooperation with the Connecticut River Watershed Council, Greenfield. Massachusetts. 132 pp.

Nislow, K.H. and B.E. Kynard. 2009. The role of anadromous sea lamprey in nutrient and material transport between marine and freshwater environments. American Fisheries Society Symposium 69: 485-494.

NOAA Fisheries. 2009. Fish passage in the United States. Making way for the nation's migrating fish. Brochure, 5 pp.

NOAA Fisheries. 2012. Diadromous fish passage: A primer on technology, planning and design for the Atlantic and Gulf coasts. 163 pp.

NOAA Fisheries. 2015. Species in the spotlight. Atlantic salmon. Northeast salmon team. Saving salmon together. 8 pp.

O'Malley, A. Size, age, and longevity of seven populations of landlocked and anadromous rainbow smelt (*Osmerus mordax*). 2016 Atlantic Salmon Ecosystems Forum, January 6-7, 2016. University of Maine, Orono, Maine.

Orsborn, J.F. 1987. Fishways – Historical Assessment of Design Practices. American Fisheries Society Symposium 1:122-130.

Palmer, M. A., E. S. Bernhardt, J. D. Allen, P. S. Lake, G. Alexander, S. Brooks, J. Carr, S. Clayton, C. N. Dahm, J. Follstad Shah, D. L. Galat, S. Gloss, P. Goodwin, D. D. Hart, B. Hassett, R.

Jenkinson, K. M. Kondolf, R. Lave, J. L. Meyer, T. K. O'Donnell, L. Pagano, and E. Sudduth. 2005. Standards for ecologically successful river restoration. *Journal of Applied Ecology* 42:208–217.

Pavlov, D.S. 1989. Structures Assisting the Migrations of Non-Salmonid Fish: USSR, FAO Fisheries Technical Paper No. 308. Food and Agriculture Organization of the United Nations. Rome, Italy. 97 pp.

Pess, G., T.P. Quinn, S.R. Gephard, and R. Saunders. 2014. Re-colonization of Atlantic and Pacific rivers by anadromous fishes: linkages between life history and the benefits of barrier removal. *Reviews in Fish Biology and Fisheries* 24 (3): 881-900. DOI 10.1007/s11160-013-9339-1.

Quintella, B. R., C. S. Mateus, J. L. Costa, I. Domingos and P. R. Almeida. 2010. Critical swimming speed of yellow- and silver-phase European eel (*Anguilla anguilla*, L.). *Journal of Applied Ichthyology* 26:432–435.

Reback, K. E., P.D. Brady, K.D. McLaughlin, and C.G. Milliken. 2004. A survey of Anadromous Fish Passage in Coastal Massachusetts (Parts 1-4). Massachusetts Division of Marine Fisheries, Department of Fisheries and Game, Executive Office of Environmental Affairs, Commonwealth of Massachusetts Technical Report No. TR-15.

Saunders R., M.A. Hachey, and C.W., Fay. 2006. Maine's diadromous fish community: past, present, and implications for Atlantic salmon recovery. *Fisheries* 31:537–547.

Shrack, E., M. Beck, R. Brumbaugh, K. Crisley, and B. Hancock. 2012. Restoration works: Highlights from a decade of partnership between The Nature Conservancy and the National Oceanic and Atmospheric Administration's restoration Center. The Nature Conservancy, Arlington, VA. 81 pp.

Stevens, J.R., J. Fisher, and R. Langton. 2016. Atlantic tomcod in the Penobscot Estuary. 2016 Atlantic Salmon Ecosystems Forum, January 6-7, 2016. University of Maine, Orono, Maine.

Towler, B., J. Turek and A. Haro. 2015. TR-2015-1. Preliminary hydraulic design of a step-pool type, nature-like fishway. University of Massachusetts, Amherst Fish Passage Technical Report. 27 pp.

Tremblay, V. 2009. Reproductive strategy of female American Eels among five subpopulations in the St. Lawrence River watershed, p. 85-102 In: *Eels at the Edge: Science, Status, and Conservation Concerns*. J. M. Casselman and D.K. Cairns (eds.). American Fisheries Society Symposium 58, Bethesda, Maryland.

USFWS. 2011. Endangered and threatened wildlife and plants; 90-day finding on a petition to list the American eel as threatened. *Federal Register* 76, Number 189: 60431-60444. September 29, 2011 (Final Rule due September 30, 2015).

USFWS 2016. Fish Passage Engineering Design Criteria. U. S. Fish and Wildlife Service, Region 5, Hadley, Massachusetts. 114 pp.

Vermont Department of Fish and Wildlife (VT DFW). 2009. Guidelines for the Design of Stream/Road Crossings for Passage of Aquatic Organisms in Vermont. 10 chapters + appendices.

Waldman, J. 2013. Running Silver. Restoring Atlantic Rivers and Their Great Fish Migrations. Lyon Press, Guilford, CT. 284 pp.

Waldman, J., K.A. Wilson, M. Mather, and N. Snyder. 2016. A resilience approach can improve anadromous fish restoration. *Fisheries* 41:3: 116-126 DOI:10.1080/03632415.2015.1134501.

Watts, D. 2012. Alewife: A Documentary History of the Alewife in Maine and Massachusetts. Poquanticut Press, Augusta, ME. 250 pp.

Weaver, C.R. 1965. Observations on the swimming ability of adult American shad (*Alosa sapidissima*). *Transactions of the American Fisheries Society* 94:382-385.

Weaver, D. 2016. Sea lamprey carcasses influence food webs in an Atlantic coastal stream. 2016 Atlantic Salmon Ecosystems Forum, January 6-7, 2016. University of Maine, Orono, Maine.

Webb, P. 2006. Stability and maneuverability. Pp 281-332 *In*: R. E. Shadwick and G. V. Lauder, eds. *Fish Physiology, Volume 23: Fish Biomechanics*. Academic Press, New York.

Webb, P.W., A. Cotel, and L.A. Meadows. 2010. Waves and eddies: effects on fish behavior and habitat distribution. *In*: *Fish Locomotion: An Eco-Ethological Perspective*. Edited by P. Domenici and B.G. Kapoor. Science Publishers, Enfield, New Hampshire. pp. 62-89.

West, D.C., A.W. Walters, S. Gephard, and D.M. Post. 2010. Nutrient loading by anadromous alewife (*Alosa pseudoharengus*): contemporary patterns and predictions for restoration efforts. *Canadian Journal of Fisheries and Aquatic Sciences* 67: 1211-1220.

Wood, R.J. and H.M. Austin. 2009. Synchronous multidecadal fish recruitment patterns in Chesapeake Bay, USA. *Canadian Journal of Fisheries and Aquatic Sciences* 66: 496-508.

Principal authors of this memorandum and their contact information:

James Turek*
Restoration Ecologist
Office of Habitat Conservation, Restoration Center
National Marine Fisheries Service
National Oceanic and Atmospheric Administration
28 Tarzwell Drive
Narragansett, Rhode Island 02882
(401) 782-3338
James.G.Turek@noaa.gov

Alex Haro, Ph.D.
Research Ecologist
Conte Anadromous Fish Research Center
U. S. Geological Survey
1 Migratory Way
Turners Falls, MA 01376
(413) 863-3806
aharo@usgs.gov

Brett Towler, Ph.D., P.E., P.H.
Hydraulic Engineer
Fish Passage Engineering
U.S. Fish and Wildlife Service
300 Westgate Center Drive
Hadley, MA 01035
(413) 253-8727
Brett_Towler@fws.gov

* Lead contact to whom comments on or queries relative to these passage guidelines should be submitted